



**H200<sup>®</sup> Wireless**

**User's Guide**



**Bioness Inc.**

25103 Rye Canyon Loop  
Valencia, CA 91355 USA  
Telephone: 800.211.9136 or 661.362.4850  
Email: [info@bioness.com](mailto:info@bioness.com)  
Website: [www.bioness.com](http://www.bioness.com)



**Bioness Europe B.V.**

Stationsweg 41  
3331 LR Zwijndrecht, The Netherlands  
Telephone: +31.78.625.6088  
Email: [international@nl.bioness.com](mailto:international@nl.bioness.com)  
Website: [www.bioness.com](http://www.bioness.com)

**Rx Only (US Only)**



H200® Wireless, Bioness, the Bioness Logo® and LiveOn® are trademarks of Bioness Inc. in the United States or other countries. | [www.bioness.com](http://www.bioness.com)

©2018 Bioness Inc.

612-00964-001 Rev. A  
03/2018



## H200 Wireless User's Guide Copyright

© 2018, Bioness Inc.

### All Rights Reserved

No part of this publication may be reproduced, transmitted, transcribed, stored in a retrieval system, or translated into any language or any computer language, in any form or by any third party, without the prior written permission of Bioness Inc.

### Trademarks

H200® Wireless, Bioness, the Bioness Logo® and LiveOn® are trademarks of Bioness Inc. in the United States or other countries. | [www.bioness.com](http://www.bioness.com)

### Rx Only (US Only)

### Bioness Patents

This product is covered by one or more US and international patents. Additional patents pending. For more information on patents visit Bioness web site at: <https://www.bioness.com/Patents.php>

### Disclaimer

Bioness Inc. and its affiliates shall not be liable for any injury or damage suffered by any person, either directly or indirectly, as a result of the unauthorized use or repair of Bioness Inc. products. Bioness Inc. does not accept any responsibility for any damage caused to its products, either directly or indirectly, as a result of use and/or repair by unauthorized personnel.



### Environmental Policy

Service personnel are advised that when changing any part of the H200 Wireless System, care should be taken to dispose of those parts in the correct manner; where applicable, parts should be recycled. For more detailed information regarding these recommended procedures, please contact Bioness Inc. Bioness Inc. is committed to continuously seeking and implementing the best possible manufacturing procedures and servicing routines.



### Bioness Inc

25103 Rye Canyon Loop  
Valencia, CA 91355 USA  
Telephone: 800.211.9136 or 661.362.4850  
Email: [info@bioness.com](mailto:info@bioness.com)  
Website: [www.bioness.com](http://www.bioness.com)



### Bioness Europe B.V.

Stationsweg 41  
3331 LR Zwijndrecht, The Netherlands  
Telephone: +31.78.625.6088  
Email: [international@nl.bioness.com](mailto:international@nl.bioness.com)  
Website: [www.bioness.com](http://www.bioness.com)

### Conformity Certification























ETL CLASSIFIED



Intertek  
3106069

# List of Symbols

	Caution
	Warning
	Double Insulated (Equivalent to Class II of IEC 536)
	Type BF Applied Part(s)
	Non-Ionizing Radiation
	Date of Manufacture
	Manufacturer
	This Product Must Not Be Disposed of with Other Household Waste
	Refer to Instruction Manual/ Booklet
	Re-Order Number
	Lot Number
	Serial Number
	Complies with United States and Canadian Product Safety Standards
	Single Patient Use
	Storage Temperature
	Complies with the European Union Medical Device Directive
	European Authorized Representative
	Humidity Limitation
	Atmospheric Pressure Limitation
<b>IP27</b>	Degree of Ingress Protection (for Orthosis)
<b>IP22</b>	Degree of Ingress Protection (for Control Unit)
	Keep Dry

# Table of Contents

List of Symbols .....	ii
<b>Chapter 1: Introduction.....</b>	<b>1</b>
Device Description.....	1
<b>Chapter 2: Safety Information .....</b>	<b>3</b>
Indications for Use.....	3
Contraindications.....	3
Warnings .....	4
Adverse Reactions .....	6
Precautions.....	6
<b>Chapter 3: Environmental Conditions that Affect Use.....</b>	<b>11</b>
Radio Frequency (RF) Communication .....	11
Travel and Airport Security .....	12
Electromagnetic Compatibility .....	13
Warnings and Cautions .....	13
<b>Chapter 4: H200 Wireless System Kit.....</b>	<b>15</b>
Contents .....	15
<b>Chapter 5: H200 Wireless Orthosis.....</b>	<b>19</b>
Flexor Support.....	20
Extensor Wing .....	22
Wing Release Handle.....	22
Wing Arm .....	23
Fitting Panels .....	24
Spiral End of the Orthosis.....	25
Thenar .....	25
Wrist Bridge .....	26
Trigger Button .....	27

Wrist Strap Attachment Ring.....	27
Wrist Strap Attachment Bar .....	27
Status Light .....	28
Stimulation Light .....	28
Audio Alerts .....	29
Rechargeable Battery and Charging Port.....	29
<b>Chapter 6: H200 Wireless Control Unit.....</b>	<b>31</b>
Operating Buttons.....	31
Indicators and Digital Display .....	33
Audio Alerts .....	35
Charging Port .....	36
<b>Chapter 7: H200 Wireless Stimulation Programs .....</b>	<b>45</b>
<b>Chapter 8: Setup Instructions .....</b>	<b>47</b>
Charging the H200 Wireless System.....	47
Checking the System Components .....	50
Preparing Your Skin.....	50
Wetting/Attaching the Cloth Electrodes .....	51
Putting on the Orthosis.....	53
<b>Chapter 9: Operating the H200 Wireless System .....</b>	<b>59</b>
RF Communication Features.....	59
Turning On the System.....	59
Turning Off the System.....	59
Testing Stimulation in the Orthosis .....	59
Selecting a Stimulation Program .....	61
Changing Stimulation Programs.....	61
Starting Stimulation .....	61
Pausing/Resuming Stimulation.....	62

Using a Neuroprosthesis Program .....	62
Open Hand .....	62
Grasp and Release.....	63
Key Grip.....	63
Stopping Stimulation.....	64
Adjusting Stimulation Intensity.....	64
Muting/Un-Muting the System Audio Alerts .....	65
<b>Chapter 10: Removing the Orthosis .....</b>	<b>67</b>
<b>Chapter 11: Maintenance and Cleaning.....</b>	<b>69</b>
Daily Maintenance and Storage .....	69
Charging .....	69
Battery Replacement: H200 Wireless Control Unit.....	69
Battery Replacement: H200 Wireless Orthosis .....	71
Cleaning .....	71
Disinfecting .....	72
<b>Chapter 12: Electronic Registration of Replacement Parts.....</b>	<b>75</b>
<b>Chapter 13: Troubleshooting.....</b>	<b>79</b>
RF Communication Failure.....	79
Frequently Asked Questions.....	79
Quick Reference Troubleshooting .....	84
<b>Chapter 14: Technical Specifications.....</b>	<b>87</b>
<b>Chapter 15: Appendix - EMI Tables.....</b>	<b>95</b>





## Introduction

Stroke and other disorders of the central nervous system (CNS) may cause long-term disability. For many people, long-term disability may impair muscle control, increase muscle spasm, reduce muscle strength, and reduce functional abilities. When the upper limb is involved, complications may include contractures (tightening of muscle), edema (swelling), pain syndromes of the hand and shoulder, and limb-neglect.

The H200 Wireless System is designed to treat the complications associated with upper limb impairment caused by stroke and other disorders of the central nervous system. The H200 Wireless System delivers electrical stimulation to the nerves of the muscles that control the hand. The H200 Wireless System may help to improve hand function and assist with tasks of daily living.

### **This H200 Wireless User's Guide describes:**

- Important safety information about the H200 Wireless System.
- The components of the H200 Wireless System.
- How to set up, operate, and maintain your H200 Wireless System.
- Troubleshooting information.

Be sure to review this guide with your clinician before using your H200 Wireless System. If you have questions contact the Bioness Client Relations Department at 800.211.9136, Option 3 (in the United States) or your local distributor (outside of the United States). You can also visit the Bioness website at [www.bioness.com](http://www.bioness.com).

## Device Description

The H200 Wireless System consists of an H200 Wireless Orthosis and a H200 Wireless Control Unit. See Figure 1-1.

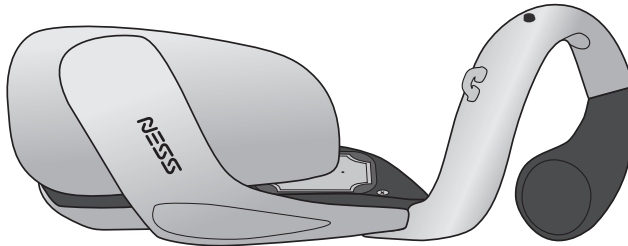

H200 Wireless Orthosis



H200 Wireless  
Control Unit

Figure 1-1: H200 Wireless Orthosis and Control Unit

### H200 Wireless Orthosis

The H200 Wireless Orthosis delivers electrical stimulation to the nerves of the muscles that control hand opening and closing and movement of the thumb. The Orthosis also stabilizes the wrist.

### H200 Wireless Control Unit

The Control Unit communicates wirelessly with the Orthosis to:

- Select a stimulation program.
- Adjust stimulation intensity.
- Start, stop, and pause a stimulation program.
- Communicate Control Unit battery status, RF communication errors, and Control Unit hardware/software malfunctions.



**Caution:** Do not put on or operate the H200 Wireless System before being properly fitted by a trained clinician.

## Safety Information

### Indications for Use

The H200 Wireless System is an electrical stimulation device indicated for the following uses:

#### Functional Electrical Stimulation (FES)

- Improvement of hand function and active range of motion in patients with hemiplegia due to stroke or upper limb paralysis due to C5 spinal cord injury.

#### NeuroMuscular Electrical Stimulation (NMES)

- Maintenance and/or increase of hand range of motion.
- Prevention and/or retardation of disuse atrophy.
- Increase in local blood circulation.
- Reduction of muscle spasm.
- Re-education of muscles.

### Contraindications

- Do not use the H200 Wireless System where a cancerous lesion is present or suspected.
- Do not use the H200 Wireless System if you have a cardiac pacemaker, implanted defibrillator, or implanted metallic device in the forearm or hand intended for the H200 Wireless use. Use of the H200 Wireless System in conjunction with any of the above may cause electric shock, burns, electrical interference, or death.
- Do not use the H200 Wireless System on an arm where a regional disorder, such as a fracture or dislocation, would be adversely affected by motion from the stimulation.

### **Warnings**

- The H200 Wireless Orthosis is to be worn only on the affected forearm and hand of the patient for whom it is fitted. It should not be worn by anyone else or on any other part of the body.
- Do not wear the H200 Wireless Orthosis over swollen, infected, or inflamed areas. Do not wear the Orthosis over skin eruptions, such as phlebitis, thrombophlebitis, and varicose veins.
- Apply stimulation to normal, intact, clean, healthy skin only.
- Turn off the H200 Wireless System before driving or operating machinery.
- Turn off stimulation before performing any activity in which involuntary muscle contractions may injure you.
- Do not use the H200 Wireless System while sleeping.
- Only trained clinicians should fit and program the H200 Wireless System.
- If the H200 Wireless Orthosis overheats, turn off stimulation and remove the Orthosis.
- If stimulation cannot be turned off using the H200 Wireless Control Unit or the trigger button on the H200 Wireless Orthosis, remove the Orthosis to stop stimulation.
- Electrical and wireless medical equipment need special precautions for electromagnetic compatibility and immunity. See Chapter 3 and the Appendix for more information.

### **Adverse Reactions**

In the unlikely event that any of the following occurs, stop using your H200 Wireless System immediately and talk to your doctor or clinician.

- Signs of significant irritation or pressure sores where the H200 Wireless Orthosis contacts the skin.
- A significant increase in muscle spasticity.
- A feeling of heart-related stress during stimulation.

- Swelling of the hand, wrist, or forearm.
- Any other unanticipated reaction.

Skin irritations and burns beneath the stimulating electrodes have been reported with the use of powered muscle stimulators.

## Precautions

- The long-term effects of chronic electrical stimulation are unknown.
- Use caution if you have suspected or diagnosed heart problems. Talk to your doctor before using the H200 Wireless System. The H200 Wireless System may cause lethal rhythm disturbances to the heart in susceptible individuals.
- Talk to your doctor if you have a spinal cord injury at the T6 level or above. Any harmful stimulation can trigger autonomic dysreflexia in patients with spinal cord injury at the T6 level and above. Symptoms of autonomic dysreflexia include acute hypertension and slow heart rate (bradycardia).
- Use caution if you have suspected or diagnosed epilepsy.
- Talk to your doctor before using the H200 Wireless System if you have any one of the following medical conditions in the affected arm:
  - Local insufficiency (insufficient blood flow).
  - Occlusion (a blood flow blockage).
  - Arteriovenous fistula for the purpose of hemodialysis (an abnormal connection between an artery and vein for the purpose of hemodialysis treatment).
  - Primary disorder of the vasculature (a disease of the arteries, veins, and lymphatics).
  - A bone deformity in the area to be stimulated.
- The safety of using the H200 Wireless System during pregnancy has not been established.
- Keep the H200 Wireless System out of the reach of children.

## H200<sup>®</sup> Wireless

- Use the H200 Wireless Orthosis with caution:
  - If you have a tendency to bleed heavily following acute trauma or fracture.
  - Following recent surgical procedures when muscle contraction may disrupt the healing process.
  - Over areas of the skin that lack normal sensation.
- Motion, muscle activity, and pressure from the H200 Wireless Orthosis may aggravate any inflammation near the Orthosis. Stop using the H200 Wireless System until any inflammation is gone.
- Always check the skin for redness or a rash when putting on and taking off the H200 Wireless Orthosis.
- After removing the H200 Wireless Orthosis, it is normal for the areas under the cloth electrodes to be red and indented. The redness should disappear in approximately one hour. Persistent redness, lesions, or blisters are signs of irritation. Stop using the H200 Wireless System until any irritation is completely gone.
- Turn off the H200 Wireless System before putting on or taking off the Orthosis. Do not turn on the H200 Wireless System until the Orthosis is on the arm and the wing is closed.
- Turn off the H200 Wireless System when at a refueling place. Do not use the H200 Wireless System near flammable fuel, fumes, or chemicals.
- Turn off the H200 Wireless System before removing or replacing the cloth electrodes.
- Remove the H200 Wireless Orthosis before wetting the cloth electrodes.
- The H200 Wireless Orthosis is splash proof. Nevertheless, protect all electronic components from contact with water, such as from sinks, bathtubs, shower stalls, rain, and snow.
- Excess body hair where the H200 Wireless cloth electrodes touch may reduce electrode contact with the skin. If necessary, remove excess body hair with an electric shaver or scissors. Do not use a razor. A razor can irritate the skin.
- Use only H200 Wireless cloth electrodes supplied by Bioness Inc.

- Do not use the H200 Wireless System without the cloth electrodes.
- Be sure the H200 Wireless cloth electrodes are wet and securely attached to the electrode bases before use.
- Wet the H200 Wireless cloth electrodes before use and after every three to four hours of use.
- Replace the H200 Wireless cloth electrodes at least every two weeks, even if they appear to be in good condition.
- Always store the H200 Wireless cloth electrodes where they can air dry.
- When putting on the H200 Wireless Orthosis, make sure the cloth electrodes uniformly contact the skin.
- Ventilate the skin by removing the H200 Wireless Orthosis for at least 15 minutes every 3 to 4 hours.
- Store the H200 Wireless Orthosis where it can air dry.
- Do not store the H200 Wireless System where temperatures may exceed the recommended storage temperature range: -25°C (-13°F) to +70°C (+158°F). Temperature extremes can damage the components.

If skin irritation or a skin reaction occurs, stop using your H200 Wireless System immediately and contact your clinician or dermatologist. Also contact the Bioness Client Relations Department: 800.211.9136, Option 3 (in the United States) or your local distributor (outside the United States). Resume use only when the skin is completely healed. Then follow a skin conditioning protocol, per the recommendation of your health-care specialist.





## Environmental Conditions that Affect Use

### Radio Frequency (RF) Communication

Several components of the H200 Wireless System communicate via radio communication. They have been tested and found to comply with the limits for a Class B digital device, pursuant to Part 15 (RF Devices) of the Federal Communications Commission (FCC) rules. These limits are designed to provide reasonable protection against harmful interference in a residential installation. This equipment generates, uses, and can radiate RF energy. If not installed and used according to the instructions, it may cause harmful interference with radio communications. However, there is no guarantee that interference will not occur in a particular installation. If this equipment does cause harmful interference to radio or television reception, which can be determined by turning the equipment off and on, try one or more of the following corrective measures:

- Reorient or move the receiving antenna.
- Increase the separation distance between the equipment and receiver.
- Connect the equipment into an outlet on a circuit different from that to which the receiver is connected.
- Consult the dealer or technician for assistance.

The antenna for each transmitter must not be near to or operating in conjunction with any other antenna or transmitter.

Portable and mobile RF communications equipment can affect the H200 Wireless System.

### Conformity Certification

The H200 Wireless System complies with Part 15 of the FCC regulations. Operation is subject to the following two conditions:

1. This device may not cause harmful interference.
2. This device must accept any interference received, including interference that may cause undesired operation.

This equipment complies with FCC RF radiation exposure limits set forth for an uncontrolled environment.

Note: FCC regulations provide that changes or modifications not expressly approved by Bioness Inc. could void authority to operate.

### Travel and Airport Security

The H200 Wireless System charger is compatible with Australian, U.K., European Union, and U.S. voltages: 100-240 VAC, 50/60 Hz.

Turn off your H200 Wireless System before going through airport security. Wear loose clothing so that you can easily show the security person your H200 Wireless System. The H200 Wireless System will likely set off the security alarm. Be prepared to remove the H200 Wireless System so that security can scan it, or ask for the system to be scanned if you do not want to remove it. You may want to carry a copy of your H200 Wireless System prescription. A prescription can be useful when passing through customs as well.

To request a copy of your prescription, call the Bioness Client Relations Department: Telephone: 800.211.9136, Option 3; or your local distributor. A Bioness representative can fax or mail you a copy.

Note: The H200 Wireless System contains radio transmitters. The Federal Aviation Administration rules require that all radio-transmitting devices be turned off during flight.

## Electromagnetic Compatibility

The H200 Wireless System is medical electrical equipment and was tested for electromagnetic compatibility (EMC) in accordance with International Electrotechnical Committee (IEC) 60601-1-2. The tables in the Appendix provide information regarding the EMC testing and guidance for safe use of the system. The H200 Wireless System should be configured and used in accordance with the instructions provided in this guide.

The H200 Wireless System was tested and certified to use the following:

- DC power supply as provided by Bioness Inc., manufactured by FRIWO, Part No. FW7555M/05.
- Y cable (2-way splitter) as provided by Bioness Inc., Model No. L3G-5C00. Manufactured by Tamuz Electronics Ltd.

The plug-in AC/DC adapters for the H200 Wireless Control Unit and Orthosis are the only means for disconnecting the devices from the AC power.

### Warnings and Cautions

- Use caution when treating patients with implanted intrathecal/intravascular drug delivery systems. During initial trials with the H200 Wireless System, clinicians should carefully monitor patients on intraspinal/intravascular therapy for any new neurological or other medical signs or symptoms. Those clinicians should be advised to inform patients of the signs and symptoms of drug underdose or overdose. Clinicians and patients also should be advised to follow programming guidelines and precautions provided in the relevant drug delivery system product manuals.
- Do not apply stimulation in the presence of electronic monitoring equipment (e.g., cardiac monitors, ECG alarms), which may not operate properly when the electrical stimulation device is in use.

## H200<sup>®</sup> Wireless

- The use of accessories, transducers, or cables other than those specified, with the exception of transducers and cables sold by the manufacturer of the H200 Wireless System as replacement parts for internal components, may result in increased emissions or decreased immunity of the H200 Wireless System.
- The use of the accessory, transducer, or cable sold by the manufacturer of the H200 Wireless System with equipment and systems other than those specified may result in increased emissions or decreased immunity of the H200 Wireless System.
- The H200 Wireless System may be interfered with by other equipment, even if that other equipment complies with CISPR (International Special Committee on Radio Interference, International Electrotechnical Commission) emission requirements.
- Do not use the H200 Wireless System within three feet of short wave or microwave therapy equipment. Such equipment may produce instability in the stimulation output by the Orthosis.

## H200 Wireless System Kit

### Contents

- H200 Wireless Orthosis
- H200 Wireless Control Unit
- System Charger Set (with Y Cable)
- Control Unit Neck Strap
- Control Unit Wrist Strap
- Control Unit Belt Pouch
- Orthosis Wrist Strap
- H200 Wireless Cloth Electrodes
- Cloth Electrode Mesh Bag
- H200 Wireless FPL Panel
- Large Thenar
- Wrist Inserts
- H200 Wireless User's Guide
- User's Reference Card

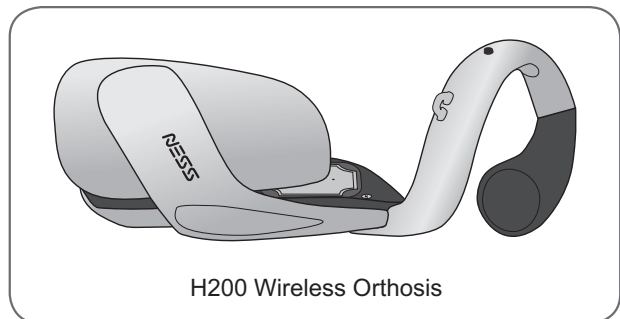
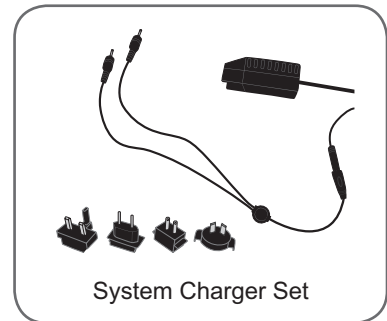

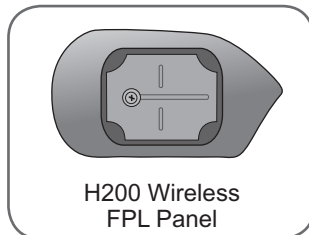
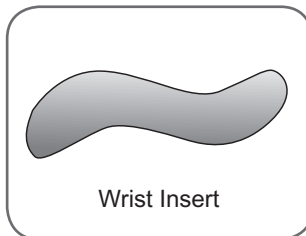
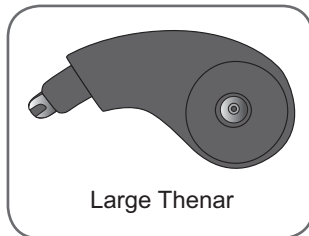
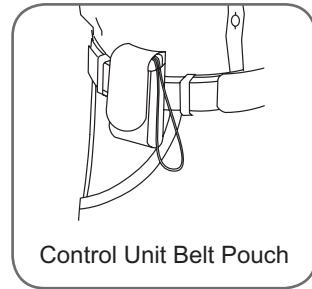
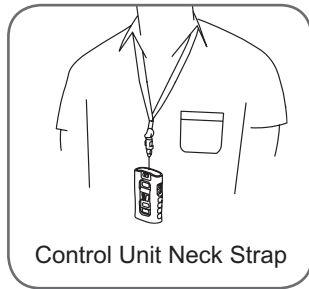
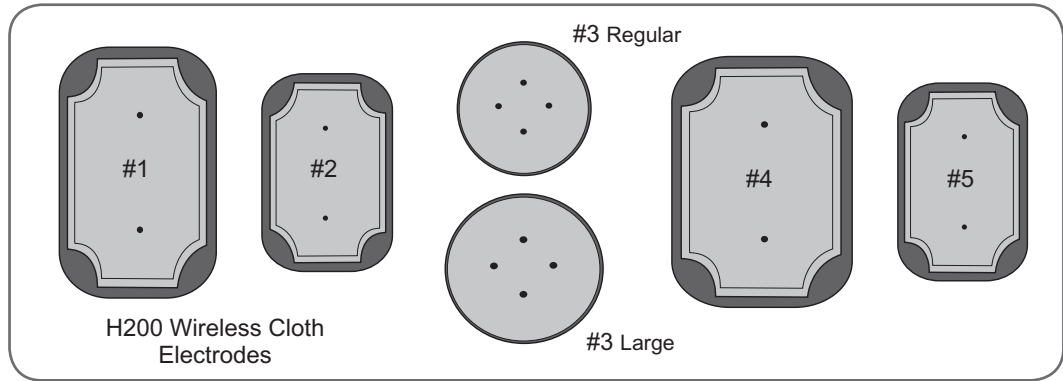

## **H200 Wireless Orthosis**

The H200 Wireless Orthosis is available in right and left configurations, and in three sizes: small, medium, and large.

## **H200 Wireless Control Unit**

The H200 Wireless Control Unit communicates wirelessly with the Orthosis to control the Orthosis and monitor system status.

## **System Charger Set (with Y Cable)**

The System Charger set is for charging the Control Unit and Orthosis.

## **Orthosis Wrist Strap**

The Orthosis Wrist Strap helps to position and stabilize the Orthosis on the arm. The Wrist Strap hooks onto the Orthosis and wraps under the wrist.

## **Control Unit Neck Strap, Wrist Strap, and Belt Pouch**

The Control Unit Neck Strap, Wrist Strap, and Belt Pouch are for carrying the Control Unit. The Neck Strap and Wrist Strap loop through the hole at the top of the Control Unit. The Belt Pouch has a clamp for attaching to a belt.

## **H200 Wireless Cloth Electrodes**

The H200 Wireless Cloth Electrodes deliver the stimulation generated by the Orthosis. The Cloth Electrodes attach to the Electrode Bases on the Orthosis.

## **Cloth Electrode Mesh Bag**

The Cloth Electrode Mesh Bag is for storing the H200 Wireless Cloth Electrodes. The Mesh Bag allows the Cloth Electrodes to air dry.





## H200 Wireless Orthosis

The H200 Wireless Orthosis generates the electrical stimulation used to open and close your hand and move your thumb. The Orthosis has an integrated radio frequency stimulation unit and five stimulating electrodes. The electrodes have been predetermined by your clinician and configured with fitting panels. See Figure 5-1.

The Orthosis responds to wireless signals from the Control Unit to turn stimulation on and off, and to adjust the stimulation intensity level.

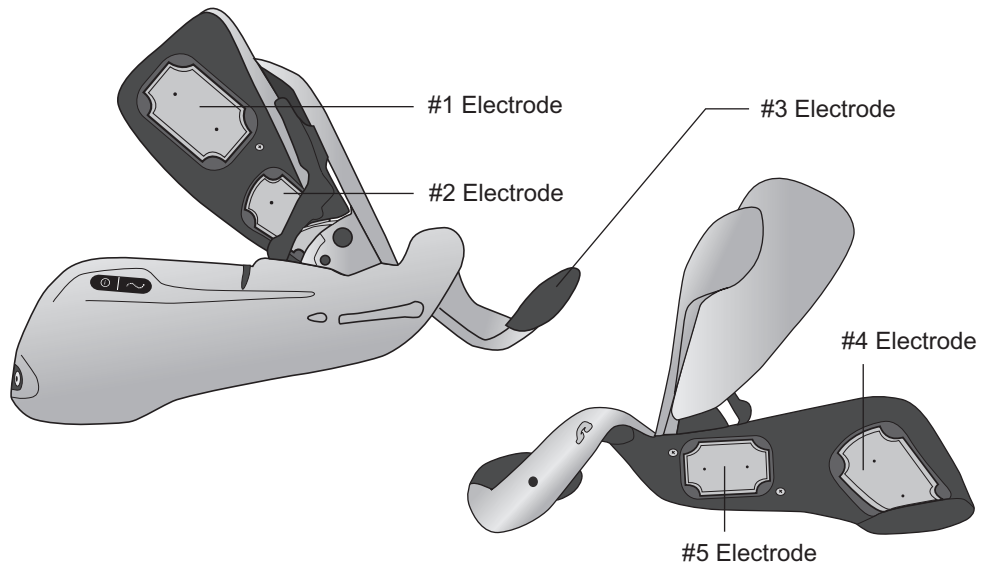

Figure 5-1: Orthosis Stimulating Electrodes

The H200 Wireless Orthosis features: (See Figure 5-2)

- A flexor support
- An extensor wing
- A spiral end
- A status light
- A stimulation light
- Audio alerts
- A rechargeable battery and charging port

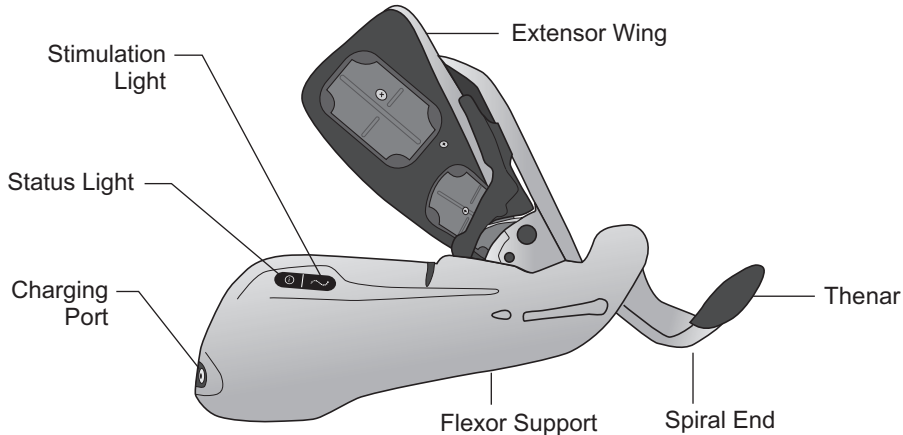

Figure 5-2: Orthosis Features

### Flexor Support

The flexor support is designed to support your forearm while delivering electrical stimulation to the nerves of the muscles that flex your hand. The flexor support includes two electrode bases: #4 and #5. See Figure 5-3.

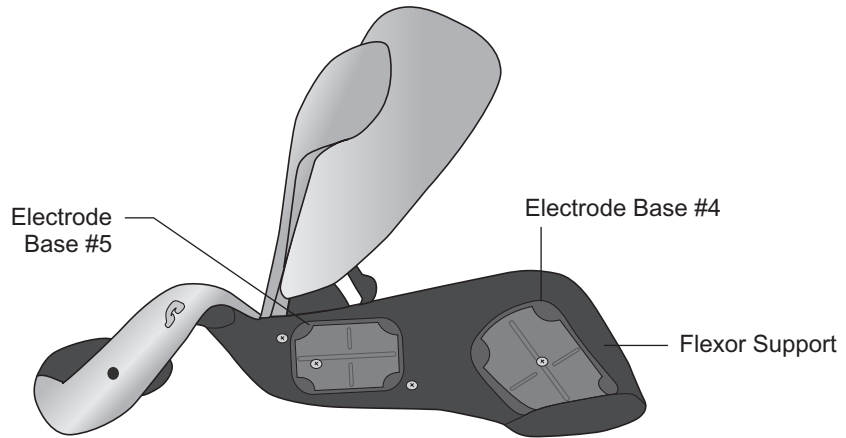

Figure 5-3: Orthosis Flexor Support

If you have a small wrist, your clinician may have fit an Flexor Pollicis Longus (FPL) panel to the Orthosis flexor support. The FPL panel fills excess space in the region of the #5 electrode base. See Figure 5-4.

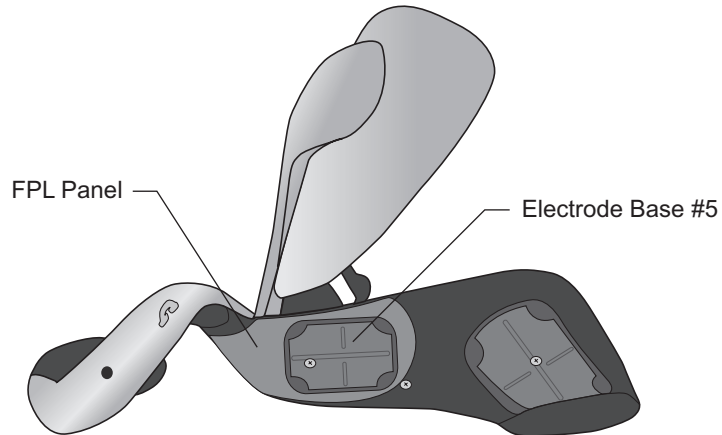

Figure 5-4: Orthosis Flexor Support with an FPL Panel

## Extensor Wing

The extensor wing delivers electrical stimulation to the nerves of the muscles that extend your hand.

### The extensor wing features: (See Figure 5-5)

- Two electrode bases: #1 and #2
- A wing release handle
- A wing arm

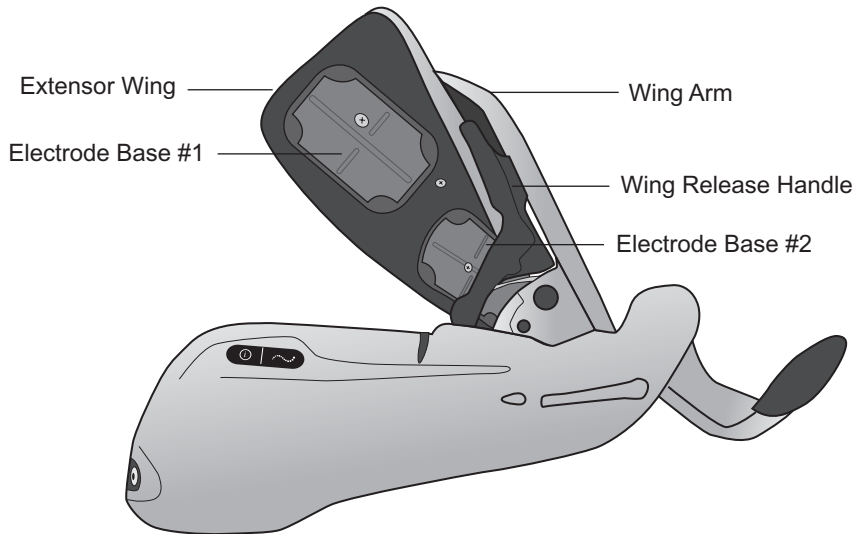

Figure 5-5: Orthosis Extensor Wing

## Wing Release Handle

The wing release handle is used to open the extensor wing. See Figure 5-6. When the wing release handle and wing arm are squeezed together, the extensor wing lifts open.

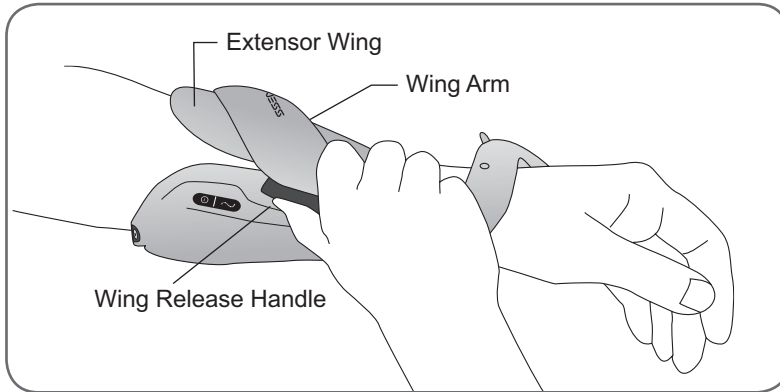

Figure 5-6: Orthosis Wing Release Handle

## Wing Arm

The wing arm is used to close the extensor wing. See Figure 5-7. When the wing arm is pushed down, the extensor wing clicks. The extensor wing is sufficiently closed when no more clicking can be heard.

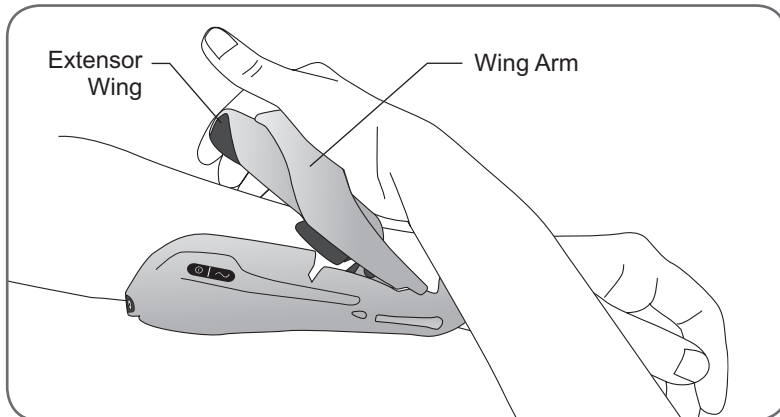

Figure 5-7: Orthosis Wing Arm

## Fitting Panels

If your fitting panels detach from your Orthosis, please follow the directions below on how to reattach the fitting panels.

### Extensor Fitting Panel

1. With the Orthosis wing open, align the extensor fitting panel to the extensor wing. See Figure 5-8.
2. Make sure the lip of the fitting panel rests outside the wing.
3. Grasp the extensor fitting panel and the extensor wing and gently press on the fitting panel until it clicks into place.

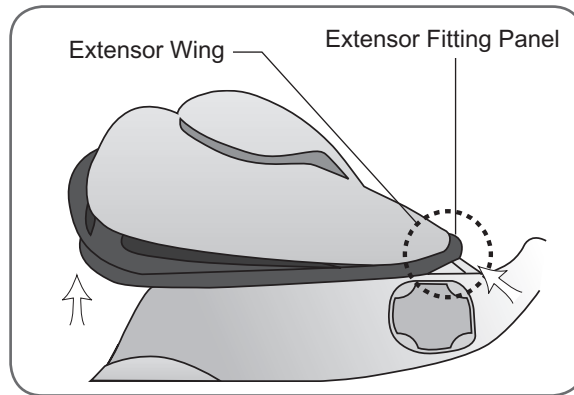

Figure 5-8: Reattaching the Extensor Fitting Panel

### Flexor Fitting Panel

1. With the Orthosis wing open, align the flexor fitting panel to the flexor support. See Figure 5-9.
2. Make sure the lip of the fitting panel rests outside the edge of the flexor support.

3. Grasp the edge of the flexor fitting panel and the edge of the flexor support and gently press together until the fitting panel clicks into place.

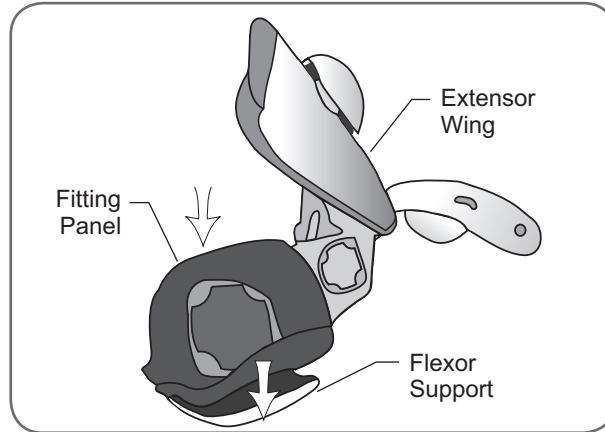

Figure 5-9: Reattaching the Flexor Fitting Panel

## Spiral End of the Orthosis

The spiral end of the Orthosis supports the hand. It also delivers stimulation to the nerves of the muscles that move the thumb.

### The spiral end features: (See Figure 5-10)

- A thenar
- A wrist bridge
- A trigger button
- An Orthosis wrist strap attachment ring
- An Orthosis wrist strap attachment bar



## Thenar

The thenar is for controlling thumb movement and is available in regular and large sizes. The snap on the thenar is for the cloth electrode placement. When the Orthosis is positioned correctly, the thenar cloth electrode should rest at the base of your thumb. See Figure 5-11.

**⚠ CAUTION:** Do not operate the H200 Wireless System without a thenar cloth electrode in place.

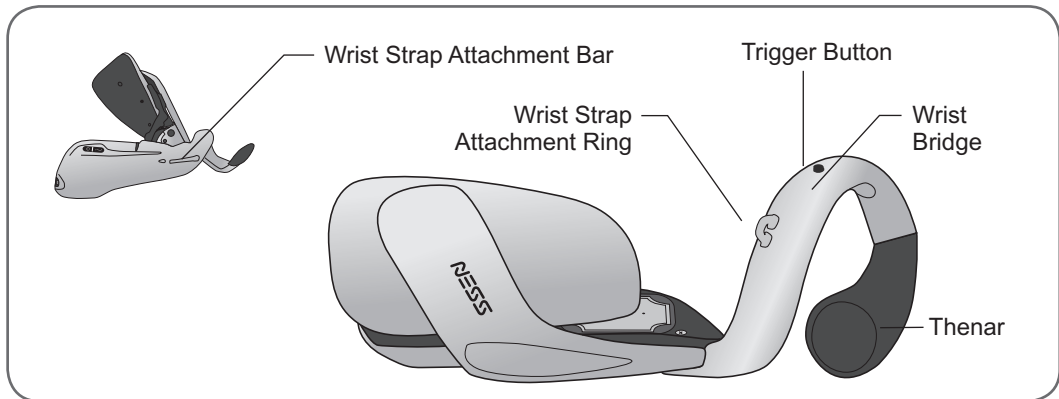

Figure 5-10: Spiral End of the Orthosis

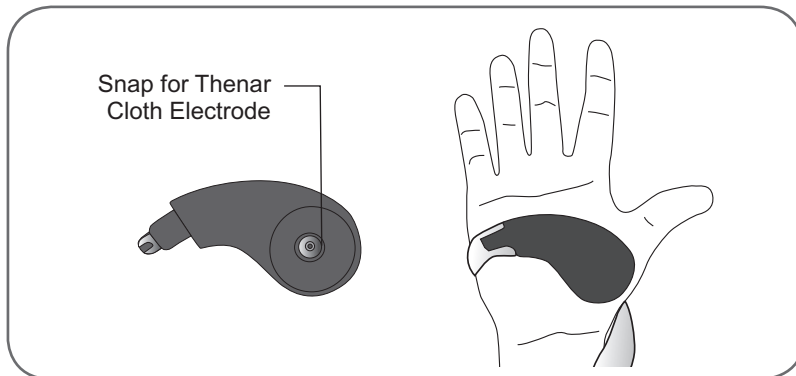

Figure 5-11: Correct Placement of Thenar

## Wrist Bridge

The wrist bridge wraps around the back of your wrist.

### The wrist bridge:

- Stabilizes the Orthosis on your hand.
- Supports your wrist in an extended position.
- Helps to keep your wrist extended during finger opening and closing.

The wrist bridge has a cushioned wrist insert on the underside to keep the H200 Wireless Orthosis positioned against your wrist.

## Trigger Button

The trigger button is used to turn on/pause stimulation. See Figure 5-10. The trigger button works like the trigger button on the Control Unit.

**Note:** If the trigger button on your Orthosis is disabled, consult your clinician.

## Wrist Strap Attachment Ring

The wrist strap attachment ring is for hooking the wrist strap to the Orthosis. See Figure 5-10.

## Wrist Strap Attachment Bar

The wrist strap attachment bar is for securing the Orthosis wrist strap around the wrist. See Figure 5-12.

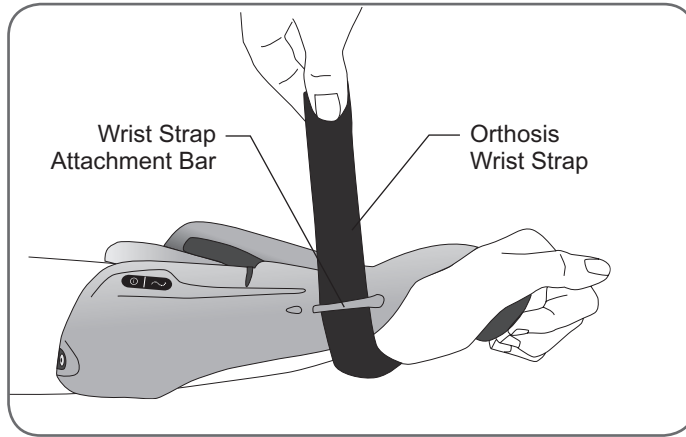

Figure 5-12: Wrist Strap Attachment Bar

## Status Light

The status light ⓘ communicates system status and error messages. See Table 5-1.

## Stimulation Light

The stimulation light 🌊 communicates whether stimulation is on, off, or paused. See Table 5-1.







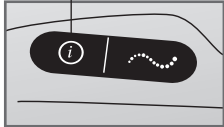

Left Orthosis	Display	Description	Definition
<p>Status Light</p> 		Flashes Green	System On
		Flashes Yellow	Low Battery
		Alternately Flashes Yellow and Green	Battery Charging
		Steady Green	Battery Fully Charged; Registration Successful
		Flashes Red	Faulty Electrode Contact
		Steady Red	Hardware/Software Error; Charging Error
<p>Stimulation Light</p> 		Steady Yellow	Stimulation Paused
		Flashes Yellow Rapidly	Stimulation On

Table 5-1: H200 Wireless Orthosis Displays

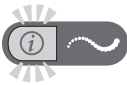
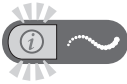
## Audio Alerts

### The Orthosis will beep when:

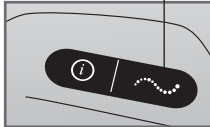
- The H200 Wireless System is turned on/off
- The Orthosis stimulation unit malfunctions
- Stimulation is turned on/off or paused

## H200<sup>®</sup> Wireless

- There is a faulty electrode contact.
- The battery charge level is low.
- A charging error occurs.
- A charger is connected.

### Rechargeable Battery and Charging Port

The Orthosis has a rechargeable battery. The charging port is located at the back of the Orthosis. See Figure 5-13.

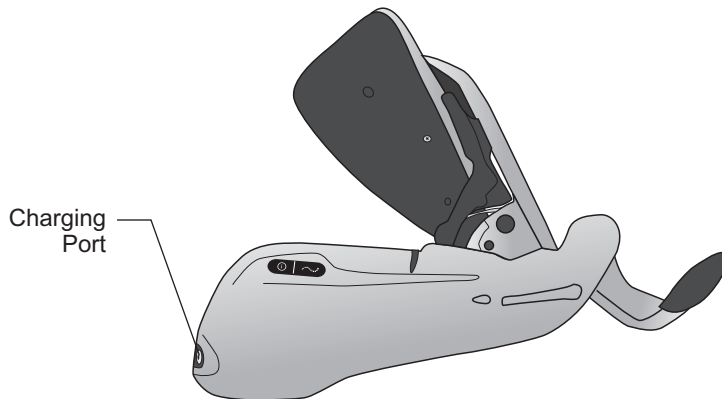

Figure 5-13: H200 Wireless Orthosis Charging Port

**Note:** While charging please make sure the orthosis is not lying on it's side, causing the trigger button to be pressed continuously. This will cause the system to reset and turn off.

# H200 Wireless Control Unit

## The Control Unit is used to:

- Turn on/off the H200 Wireless System
- Test stimulation in the Orthosis
- Select a stimulation program
- Turn on/off or pause stimulation
- Adjust the stimulation intensity level
- Monitor system status
- Mute system audio alerts

## Operating Buttons

The Control Unit has eight operating buttons. See Figure 6-1, Table 6-1, and Table 6-2.

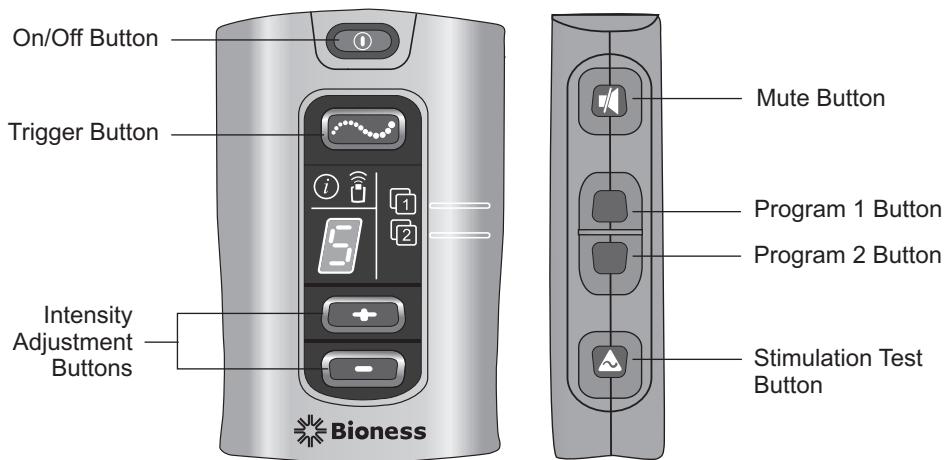

Figure 6-1: Control Unit Operating Buttons









Operating Button	Description	Function
	On/Off Button	Turn System On/Off
	Trigger Button	Turn Stimulation On/Off or Pause Stimulation
	Intensity Adjustment Buttons	 Increase Stimulation Intensity  Decrease Stimulation Intensity
	Mute Button	Mute/Un-Mute the Control Unit and H200 Wireless Orthosis Audio Alerts
	Program Selection Buttons	Top: Select Program 1 Bottom: Select Program 2
	Stimulation Test Button	Test Stimulation in the H200 Wireless Orthosis

Table 6-1: Control Unit Operating Button Functions





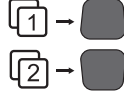

Visual Display	Description	Definition
	On/Off Button Flashes Green	System On
	Trigger Button Flashes Yellow Rapidly	Stimulation On
	Trigger Button is Steady Yellow	Stimulation Paused

Table 6-2: Control Unit Operating Button Visual Displays

## Indicators and Digital Display

### The Control Unit front panel features: (See Figure 6-2)

- A Control Unit status indicator: 
- An RF communication indicator: 
- Program 1 and Program 2 selection indicators:  
- A digital display

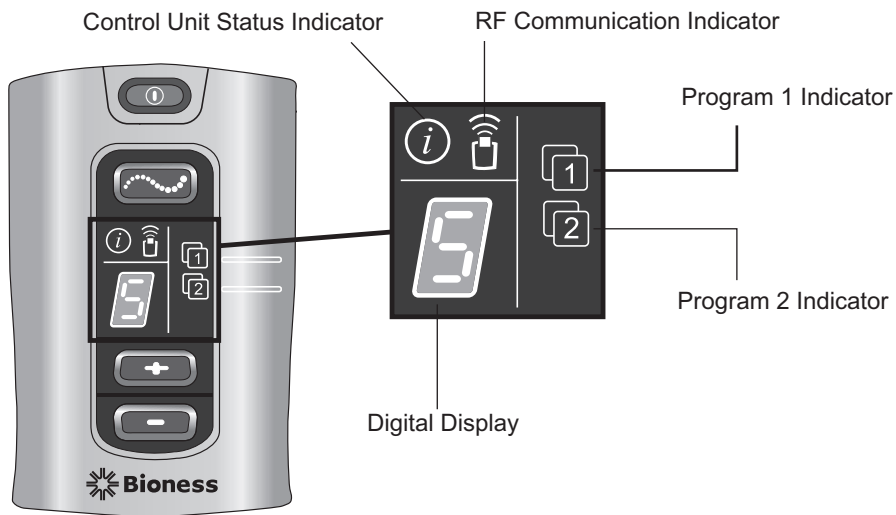

Figure 6-2: Control Unit Digital Display and Indicators.

### The Control Unit indicators show: (See Table 6-3)

- Control Unit status
- Stimulation program selected
- Control Unit low battery
- RF communication status











Indicator	Description	Definition
	Control Unit Status Indicator Flashes Yellow	Control Unit Low Battery
	Control Unit Status Indicator is Steady Red	Control Unit Charging Error; Electronic Registration Error; Control Unit Hardware/Software Error
	Program 1 Indicator is Green	Program 1 Selected
	Program 2 Indicator is Green	Program 2 Selected
	RF Communication Indicator Flashes Red	RF Communication Error

Table 6-3: Control Unit Indicator Lights

### The Control Unit digital display shows: (See Table 6-4)

- Stimulation intensity level: 0–9
- Electronic registration status
- Battery charging status

Display	Description	Definition
	0–9	Stimulation Intensity Level; "0" Equals No Stimulation
	Alternating Green Arches	Registration in Process
	Letter "C"	Registration Complete
	Letter "E"	Registration Error



Display	Description	Definition
	Letter "U"	Control Unit Unregistered
	Rotating Green Circle	Control Unit Charging
	Horizontal Green Line	Control Unit Fully Charged

Table 6-4: Control Unit Digital Displays

## Audio Alerts

### The H200 Wireless Control Unit beeps to indicate:

- Electronic registration was initiated, successful, or unsuccessful.
- The H200 Wireless System was turned on/off.
- A program has ended and stimulation has stopped.
- A Control Unit hardware/software error occurred.
- The Control Unit battery charge level is low.
- The audio alerts were muted/un-muted.
- A charger was connected or disconnected.
- RF communication failed.
- A button was pressed.
- A charging error occurred.

## Charging Port

The Control Unit is powered by a single rechargeable NiMH AAA battery.

**⚠ CAUTION:** Use only a battery supplied by Bioness Inc.

The Control Unit charging port is located at the bottom of the Control Unit, under the flexible cover. See Figure 6-3.

Note: Next to the charging port is the signal input/output port for the clinician's programmer.

**⚠ CAUTION:** The signal input/output port on the Control Unit is only to be used by the clinician during setup.

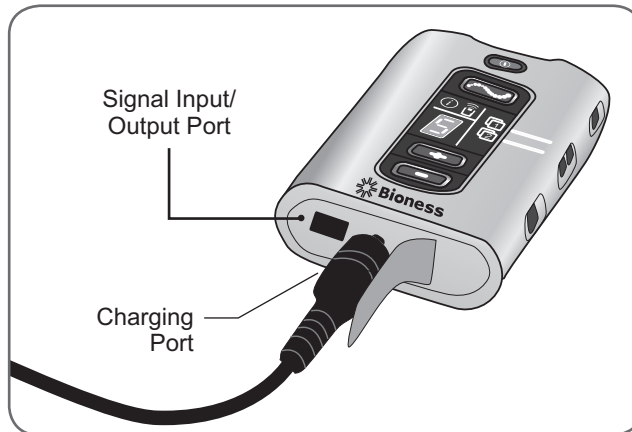

Figure 6-3: Control Unit Charging Port

## H200 Wireless Stimulation Programs

The H200 Wireless System supports Functional Training, Neuroprosthesis, and Motor Neuromodulation programs designed to open and close the hand.

Functional Training programs are designed to exercise your hand. They consist of repetitive opening and/or closing motions with a relaxation pause between each motion.

Neuroprosthesis programs are designed to assist with the performance of a specific functional task, such as opening a door or holding a cup.

Motor Neuromodulation programs deliver rapid bursts of stimulation to the flexor and extensor muscles, the flexor muscles only, or the extensor muscles only.

### **During your clinical/therapy sessions:**

- Your clinician will select the stimulation programs that best fit your therapeutic needs.
- Assign programs to the program buttons on your Control Unit for you to use at home.
- Customize the programs based on your specific impairment.



# Setup Instructions

## Charging the H200 Wireless System

It is important to charge your H200 Wireless System daily and for at least four hours before a fitting/programming session. Bioness recommends charging the Control Unit and the Orthosis at the same time.

### To charge the H200 Wireless System:

1. Select the interchangeable blade that matches your power outlet. Four blades are provided for use in the US, the European Union, Australia, and the United Kingdom. See Figure 8-1.

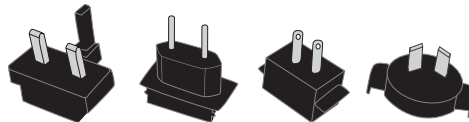

Figure 8-1: System Charger Interchangeable Blades

2. Slide the selected blade into the System Charger. See Figure 8-2.

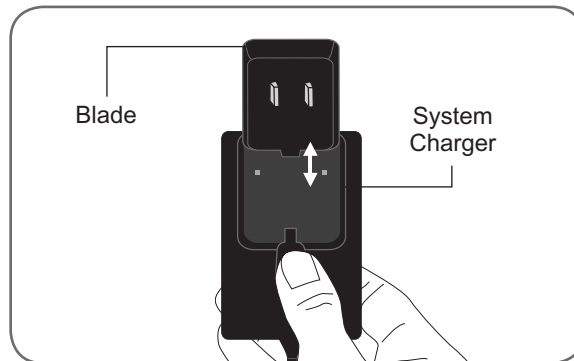

Figure 8-2: Sliding the Blade into the System Charger

3. Connect the Y Cable to the System Charger. Connect the end of the Y Cable, with the 2 cables, to the charging ports of the Orthosis and Control Unit. The Control Unit charging port is under the flexible cover. See Figure 8-3.

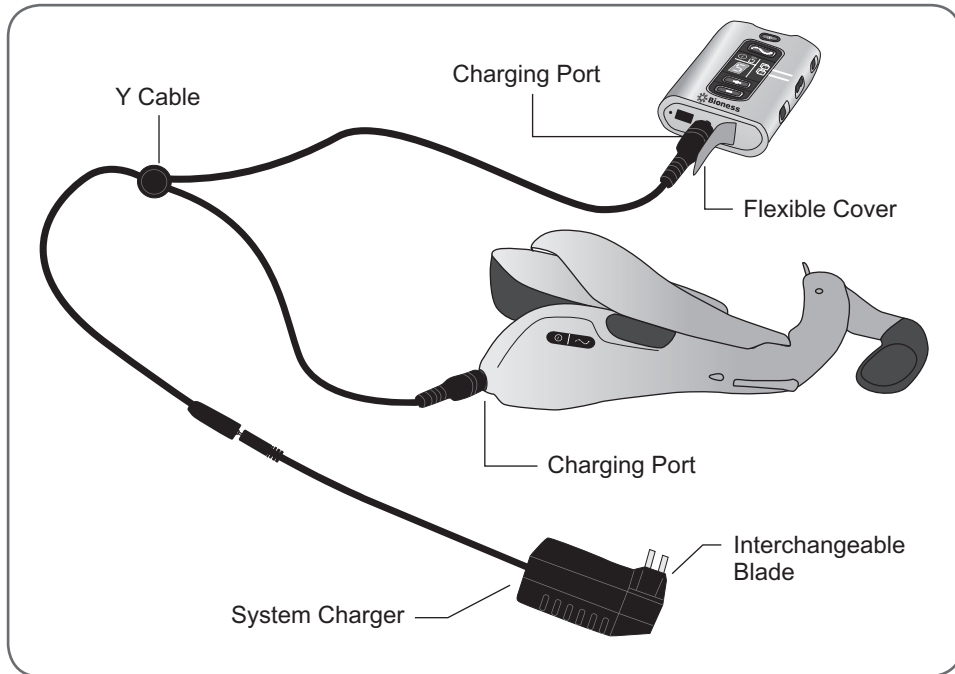







Figure 8-3: Charging Setup

4. Plug the System Charger into a power outlet.
5. If the Control Unit is charging, a rotating green circle  will appear in the Control Unit digital display. See Table 8-1.
6. If the Orthosis is charging, the status light on the Orthosis will alternately flash yellow and green . See Table 8-2.

 **Caution:** Use only the charger included in your H200 Wireless System Kit. Use of any other charger could damage the system.

 **Caution** Make sure your hands are dry before connecting the System Charger to a power outlet.

 **Caution:** Do not use the Orthosis while charging, as its surface may reach high temperatures.



Control Unit Display	Description	Definition
	Rotating Green Circle in Digital Display	Battery Charging
	Horizontal Green Line in Digital Display	Battery Fully Charged
	Status Light is a Steady Red	Charging Error

Table 8-1: H200 Wireless Control Unit Charging Displays





Orthosis Display	Description	Definition
	Status Light Alternately Flashes Yellow and Green	Battery Charging
	Status Light is a Steady Green	Battery Fully Charged

Table 8-2: H200 Wireless Orthosis Charging Displays

**The charging process is complete when:**

- A horizontal green line  appears in the Control Unit digital display.
- The status light  on the Orthosis is a steady green.

The charging process should last approximately four hours. The Control Unit can take up to six hours to charge.



Note: Keep the Control Unit and Orthosis connected to the System Charger until ready for use.

 **Caution:** To completely disconnect the power input, the AC/DC adapter portion of the System Charger set must be disconnected from the main power supply.

## Checking the System Components

### Before using your H200 Wireless System:

- Visually inspect the Orthosis and Control Unit for signs of damage.
- The cloth electrodes must be replaced every two weeks. If the cloth electrodes are old or damaged discard them. Open a new set of cloth electrodes.
- Open the Orthosis and check the electrode bases to see if they are clean. If necessary, clean the electrode bases. See the "Maintenance and Cleaning" chapter of this guide.
- Make sure your Orthosis and Control Unit are charged.

Do not use your H200 Wireless System if a component appears to be damaged. If you have any questions about your H200 Wireless System, contact the Bioness Client Relations Department at 800.211.9136, Option 3 (in the United States) or your local distributor (outside of the United States).

 **Caution:** Extreme temperatures may damage your system. Store your H200 Wireless System where it will not be exposed to extreme temperatures or humidity. See the environmental ranges in the Technical Specifications chapter of this guide for safe storage conditions.

## Preparing Your Skin

 **Caution:** Do not wear the Orthosis over broken skin.

Before putting on your Orthosis, always check your skin for signs of irritation. If any irritation is present, do not put on the Orthosis and contact your clinician. Wait for

complete healing before using the H200 Wireless System. For optimal stimulation, the skin under the Orthosis should be clean and healthy. To prepare the skin:

1. Remove any jewelry from your hand, wrist, and forearm.
2. Clean the skin where the cloth electrodes will touch with a wet washcloth. If any lotions are on the skin, clean the skin with soap and water. Rinse well.
3. If necessary, trim excess body hair from the area using an electric shaver or scissors. Do not use a razor. A razor can irritate the skin.

### Wetting/Attaching the Cloth Electrodes

 **Caution:** Before wetting the cloth electrodes, always remove them from the Orthosis.

 **Caution:** The cloth electrodes must be replaced every two weeks or sooner if they become damaged.

1. Make sure the H200 Wireless System is turned off.
2. Place the Control Unit where it cannot be splashed.
3. Wet the cloth electrodes until they are saturated. See Figure 8-4.
4. Blot excess water from the cloth electrodes. See Figure 8-4.

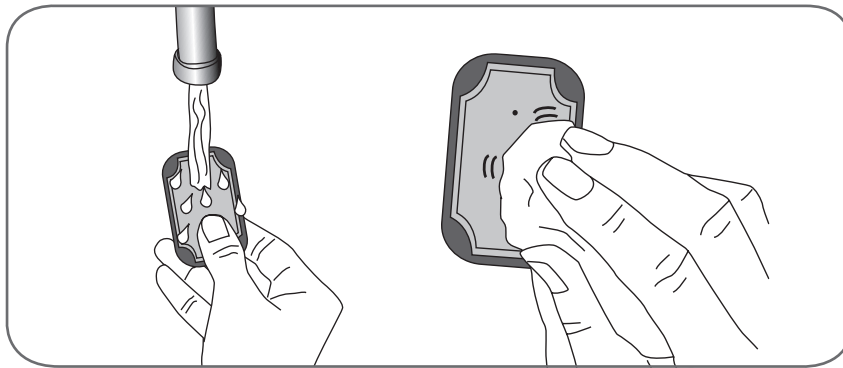

Figure 8-4: (Left) Wetting the Cloth Electrode (Right) Blotting the Cloth Electrode

5. Match each cloth electrode to its corresponding electrode base. See Figure 8-5.

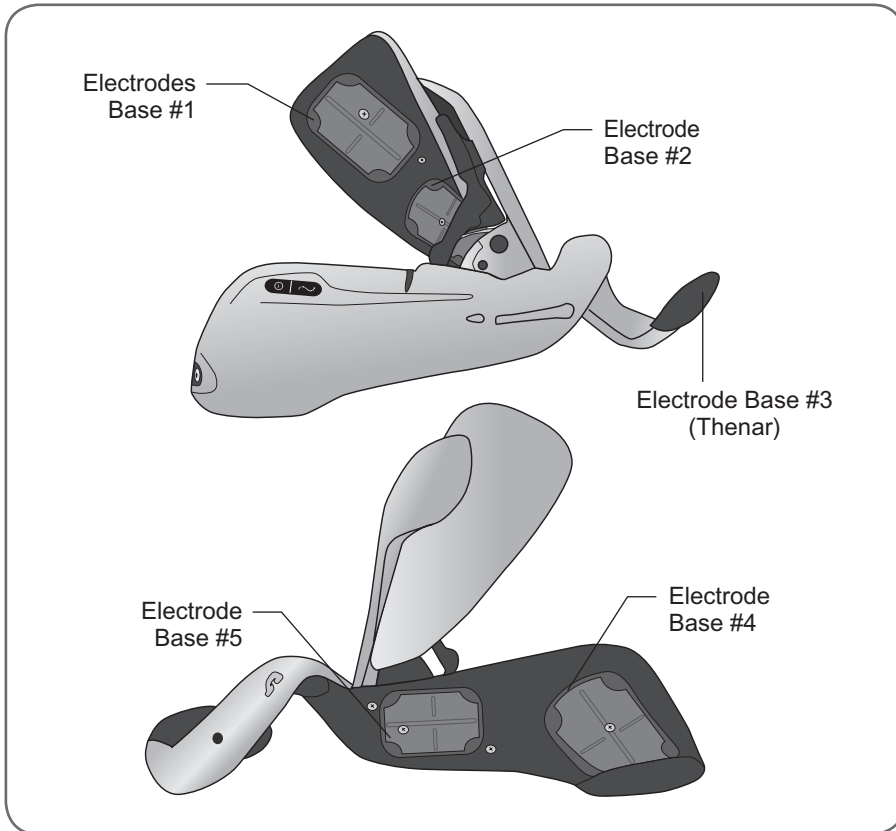

Figure 8-5: Electrode Bases #1-#5

6. Snap cloth electrode #3 to the thenar.

**Note:** The #3 large cloth electrode is for large thenars only.

7. For cloth electrodes #1, 2, 4, and 5, face the white dot on the cloth electrode toward the electrode base. Insert the corners of the cloth electrode into the electrode base. See Figure 8-6.

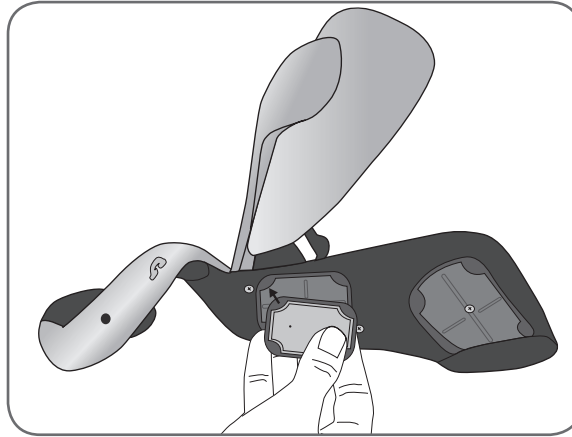



Figure 8-6: Inserting Cloth Electrode into Electrode Base

8. Check that each cloth electrode is securely attached to its corresponding electrode base.

**Note:** Remove and rewet the cloth electrodes every time you remove the Orthosis from your arm for more than one hour, and after every three to four hours of use. If the cloth electrodes dry out, your response to the stimulation may change. If you need to adjust stimulation intensity more often than usual, try rewetting the cloth electrodes.

 **Caution:** Use only cloth electrodes supplied by Bioness Inc.

 **Caution:** The cloth electrodes are to be used by no more than one individual patient. They are for single patient use only.

## Putting on the Orthosis

Make sure you are sitting upright and centered (not leaning to one side). Your arm should be comfortable and your shoulder relaxed.

**To put on the Orthosis:**

1. Position the Orthosis on a stable surface, and place your hand in the spiral end of the Orthosis. The Thenar (with attached Thenar Cloth Electrode) should rest at the base of your thumb. See Figure 8-7.

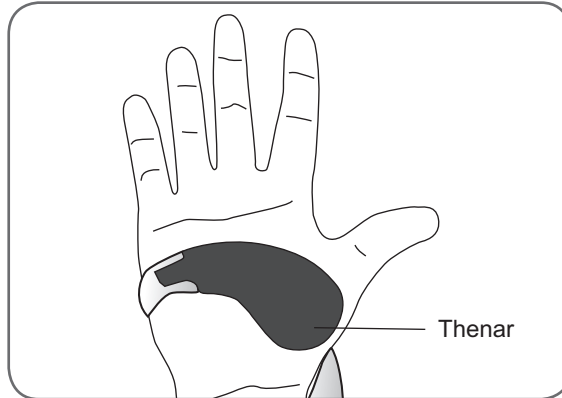

Figure 8-7: Positioning the Thenar

2. Position the Orthosis Wrist Bridge comfortably on the back of your wrist. See Figure 8-8.

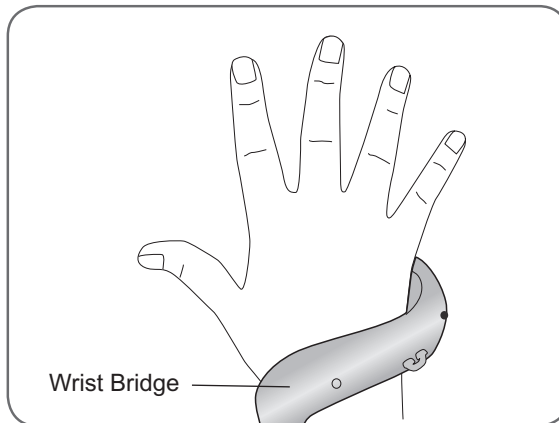

Figure 8-8: Positioning the Wrist Bridge

3. Place your forearm in the Orthosis Flexor Support. See Figure 8-9.

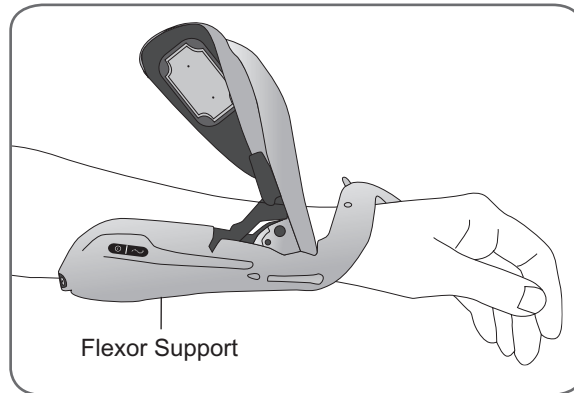

Figure 8-9: Positioning the Flexor Support

4. Place your hand on top of the Wing Arm and grasp under the Extensor Wing with your fingers.
5. Pull the Extensor Wing out while pushing down on the Wing Arm. See Figure 8-10. Push down until the clicking sound stops.

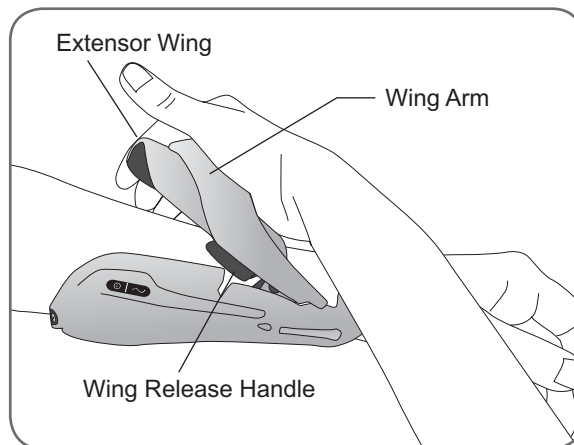

Figure 8-10: Closing the Extensor Wing

6. Attach the hook on the Orthosis Wrist Strap to the Wrist Strap Attachment Ring. See Figure 8-11.

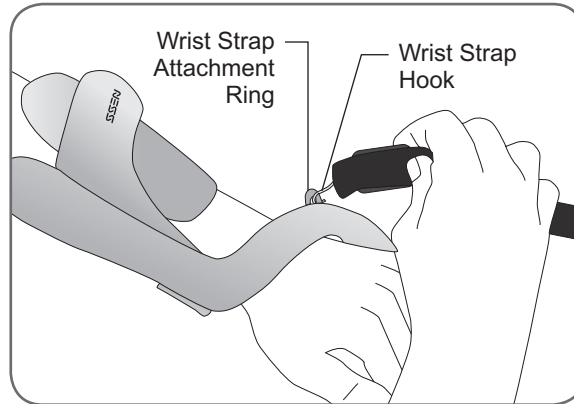

Figure 8-11: Attaching the Wrist Strap Hook

7. Bring the Wrist Strap under the wrist. Make sure the cushion on the Wrist Strap is touching the wrist.
8. Pull the Wrist Strap up and through the Wrist Strap Attachment Bar. See Figure 8-12.

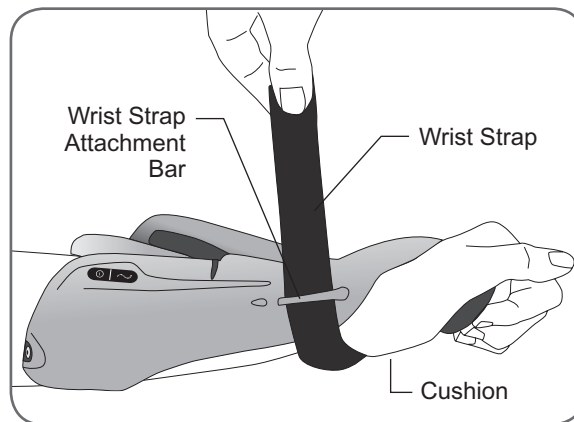



Figure 8-12: Attaching the Wrist Strap

9. Bring the Wrist Strap over the Attachment Bar and press to fasten.

 **Warning:** Do not turn on stimulation until your Orthosis is completely set up and correctly attached to your arm.

 **Caution:** Do not wear the Orthosis without the cloth electrodes.

 **Caution:** Do not pull down on the Wrist Strap. Pulling down on the Wrist Strap can break the Wrist Strap Attachment Bar.

 **Caution:** Do not tighten the Wrist Strap so much that it interferes with blood flow to the hand.





# Operating the H200 Wireless System



## RF Communication Features

The Control Unit and Orthosis must be within RF communication range to communicate wirelessly. The communication range is approximately 3 meters (10 feet). If RF communication fails, the RF communication indicator  on the H200 Wireless Control Unit will flash red .

## Turning On the System

Press the On/Off button  on the Control Unit once. The system will start in standby mode. All display indicators on the Control Unit and the Orthosis will light up for a few seconds while the system performs a self-test.

### When the system is on:

- The On/Off button  on the Control Unit will flash green.
- The status light  on the Orthosis will flash green.

## Turning Off the System

Press the On/Off button  once.

## Testing Stimulation in the Orthosis

The stimulation test button  is for testing whether the Orthosis is positioned correctly on the arm. The button is located on the side of the Control Unit. See Figure 9-1.

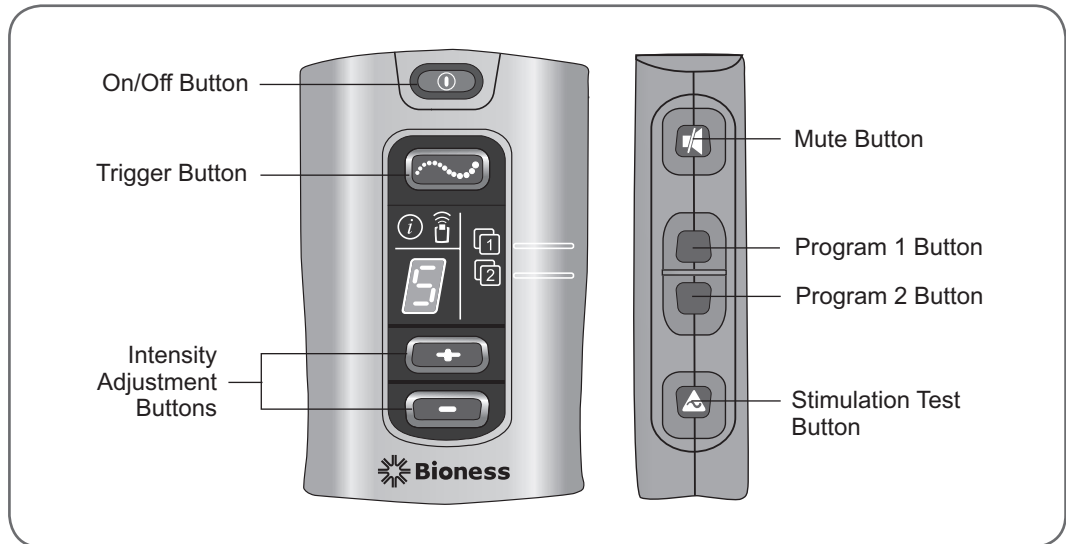





Figure 9-1: Control Unit Operating Buttons

### To test stimulation in the Orthosis:

1. Make sure the system is in standby mode. The trigger button  should not be lit.
2. Press and hold the  stimulation test button to test stimulation of the extensor muscles, which will open the hand and extend the fingers. (Stimulation will turn on and stay on until the button is released.) When stimulation is on, the  trigger button will Flash Yellow Rapidly.
3. Release the  stimulation test button to turn off stimulation.
4. Repeat to test stimulation of the flexor muscles, which will close the hand.
5. If the Orthosis is not positioned correctly:
  - Turn off the system.
  - Open the Orthosis wing and remove the Orthosis. **Do not slide the Orthosis on your arm.** Refer to the "Removing the Orthosis" chapter in this guide.

- Recheck the cloth electrodes to make sure they are positioned correctly and wet.
- Put the Orthosis back on.
- Close the Orthosis Extensor Wing until no clicking can be heard.
- Retest stimulation.

## Selecting a Stimulation Program



### To select Program 1:

Turn on the system. Program 1 is selected automatically. When Program 1 is selected, the Program 1 indicator  will be Green.

### To select Program 2:



Turn on the system. Press the Program 2 button. See Figure 9-1. When Program 2 is selected, the Program 2 indicator  will be Green.

## Changing Stimulation Programs

1. Press the trigger button  to pause stimulation.
2. Press the Program 1  or Program 2  button.
3. Your hand will start moving per the program selected.

## Starting Stimulation

To turn stimulation on press the trigger button  on the Control Unit or the trigger button on the Orthosis.

- The Control Unit will beep.
- The Control Unit trigger button  will flash yellow.
- The Orthosis stimulation light  will flash yellow rapidly.

Note: Some of the programs contain rest periods. A rest period will last for at least one minute. During a rest period, stimulation will turn off and the Orthosis stimulation light will flash yellow slowly. The Control Unit trigger button will continue to flash yellow.

### Pausing/Resuming Stimulation

Functional Training and Motor Neuromodulation Programs may be programmed to run from 5 minutes to 120 minutes, as determined by your clinician. Personal Custom Programs may be programmed to run from 30 to 240 minutes, as determined by your clinician. Once started, these programs will continue until they are finished. However, they may be paused and resumed at any time.

#### To pause/resume stimulation:

To pause stimulation press the trigger button  on the Control Unit or the trigger button on the Orthosis. When the program is paused:

- The Control Unit trigger button  will be a steady yellow.
- The Orthosis stimulation light  will be a steady yellow.

Note: Neuroprosthesis programs cannot be paused. Pressing the trigger button when stimulation is on starts the second phase of a Neuroprosthesis program.

 **Caution:** Remove the Orthosis to stop stimulation when the Control Unit is not operable or accessible and the Orthosis trigger button is disabled.

### Using a Neuroprosthesis Program

Your clinician may have assigned a Neuroprosthesis Program to the Program 1 or Program 2 button on your Control Unit. Neuroprosthesis programs are used to perform a specific task. There are three types of Neuroprosthesis Programs: Open Hand, Grasp and Release, and Key Grip.

## Open Hand

### To use Open Hand:

1. Press the Control Unit trigger button  or the trigger button on the Orthosis, to start stimulation. Your hand will open.
2. Your hand will remain open until you press the Control Unit trigger button or the trigger button on the Orthosis a second time, turning off stimulation.

Note: Do not use the Open Hand program for more than 30 seconds at a time. Your muscles may begin to fatigue.

## Grasp and Release

### To use Grasp and Release:

1. Press the Control Unit trigger button  or the trigger button on the Orthosis, to start stimulation. Your hand will open.
2. While your hand is open, place it next to the object you want to grasp.
3. After several seconds, your hand will close, allowing you to grasp the object.
4. When you are ready to release the object, press the Control Unit trigger button or the trigger button on the Orthosis a second time. Your hand will open, allowing you to release the object.
5. Stimulation will then stop. Your hand will relax.

Note: If stimulation turns off abruptly, the object will release from your grasp.

## Key Grip

### To use Key Grip:

1. Press the Control Unit trigger button  or the trigger button on the Orthosis, to start stimulation. Your fingers will close and your thumb will open. There should be a gap between your thumb and the side of your index finger.

2. While your fingers and thumb are in this position, place the object you want to grip into the gap.
3. After several seconds, your fingers and thumb will close around the object.
4. When you are ready to release the object, press the Control Unit trigger button or the trigger button on the Orthosis a second time. Your hand will open, allowing you to release the object.
5. Stimulation will then stop. Your hand will relax.

### Stopping Stimulation



Press the Control Unit trigger button  or the trigger button on the Orthosis. Stimulation will turn off.

Note: In a Neuroprosthesis program press the On/Off button  on the Control Unit to stop stimulation immediately.

### Adjusting Stimulation Intensity

Each time you turn on your Control Unit, the stimulation intensity level will be “5”. If necessary, you can adjust the stimulation intensity level when in standby mode or when stimulation is on.

#### To adjust stimulation intensity:

1. Press the plus button  on the Control Unit once to increase stimulation intensity one level.
2. Press the minus button  on the Control Unit once to decrease stimulation intensity one level.

The Control Unit will beep with each change in level. The new level will appear in the digital display.

Note: An intensity level of “0” equals no stimulation.

Note: When the system is turned on the next time, the default stimulation intensity level set by your clinician (“5”) will be restored.

## Muting/Unmuting the System Audio Alerts

To mute or unmute the system, press the mute button  briefly. The mute button is located on the side of the Control Unit. Audio alerts are listed in Table 9-1.

Note: When the system is turned on the next time, the default volume setting will be restored.

Types of Audio Alerts	Muting Allowed
Faulty electrode contact	Yes
Changes in software state	Yes
Power supply detected	Yes
Charging error	No
Software/Hardware error	No
Battery depletion threshold reached	No
Orthosis electronic registration successful/unsuccessful	No

Table 9-1: Types of Audio Alerts





## Removing the Orthosis

### To remove the Orthosis:

1. Press the Control Unit On/Off button  to turn off the H200 Wireless System.
2. Carefully unfasten the Wrist Strap and slide it away from the Wrist Strap Attachment Bar. See Figure 10-1.

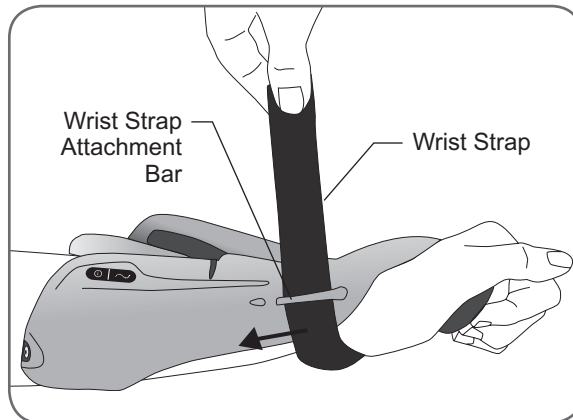

Figure 10-1: Unfastening the Wrist Strap

3. Pinch the Wing Release Handle and Wing Arm together and open the Extensor Wing. See Figure 10-2.
4. With the Extensor Wing open (See Figure 10-3), remove the Flexor Support from under your forearm.
5. Then lift the Flexor Support up and over your forearm, and remove the spiral end of the Orthosis from your hand.
6. Remove the cloth electrodes from the Orthosis.
7. Store the cloth electrodes and Orthosis in a location where they can air dry.

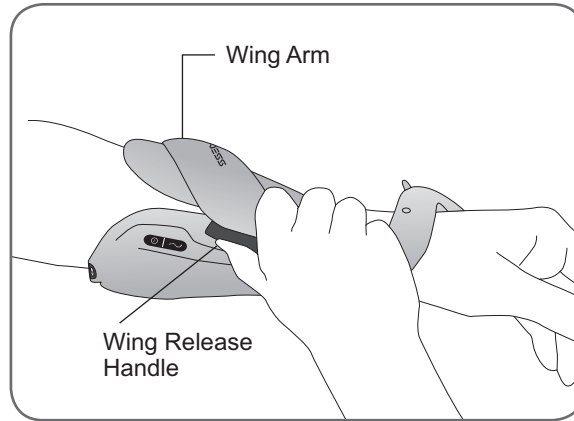

Figure 10-2: Opening the Extensor Wing

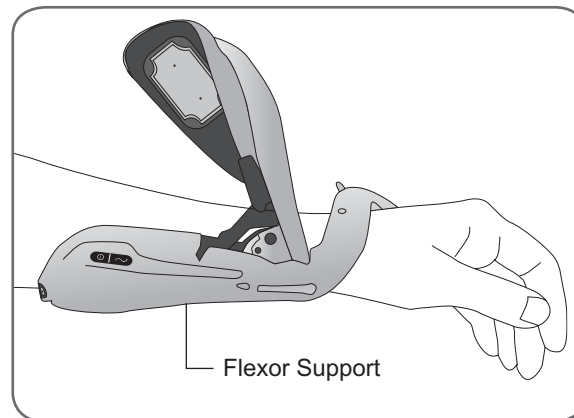

Figure 10-3: Removing the Flexor Support

## Maintenance and Cleaning

### Daily Maintenance and Storage

1. Store the H200 Wireless cloth electrodes in the cloth electrode mesh bag or where they can air dry.
2. Check the system components for signs of wear and damage.
3. Replace any components that appear old, worn, or damaged. Contact the Bioness Client Relations Department 800.211.9136, Option 3 (in the United States) or your local distributor (outside the United States) for assistance.
4. Store the Orthosis where it can air dry.
5. Charge the Orthosis and Control Unit until ready to use.

### Charging

The Control Unit and Orthosis batteries should be charged daily. Charging instructions can be found in the "Setup Instructions" chapter of this guide.

### Battery Replacement: H200 Wireless Control Unit

The battery in the Control Unit is a rechargeable AAA NiMH battery. It should be replaced approximately every two years.

#### To replace the Control Unit battery (AAA NiMH 1.2 V):

1. Using a Phillips screwdriver, remove the screw from the battery cover on the back of the Control Unit. See Figure 11-1.

Note: The screw is under a small label. Gently peel off the end of the label. Reapply the label after the battery is replaced.

2. Remove the battery cover.
3. Note the "+/-" orientation of the old battery.
4. Remove the old battery.
5. Insert the new rechargeable battery in the proper "+/-" orientation.
6. Slide the cover into place.
7. Tighten the screw.
8. Fully charge the new battery before use.

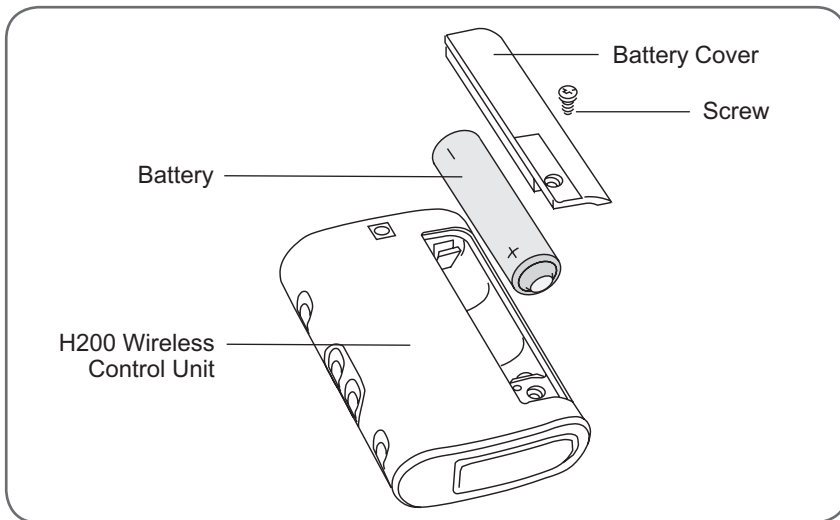



Figure 11-1: Replacing the Control Unit Battery

 **Caution:** Use only a battery supplied by Bioness Inc.

 **Caution:** Use of a non-rechargeable AAA battery can damage the H200 Wireless Control Unit.

 Remove the old battery, and properly dispose of it according to your local environmental regulations.

## Battery Replacement: H200 Wireless Orthosis

The Orthosis has a rechargeable battery that can only be replaced by a Bioness authorized representative. If the battery needs to be replaced, contact the Bioness Client Relations Department, at 800.211.9136, Option 3 (in the United States) or your local distributor (outside of the United States).

## Cleaning

### General Instructions

All H200 Wireless System Kit components may be cleaned as needed or weekly by carefully wiping them with a damp cloth. Use water. Do not use detergents or other cleaning agents, unless otherwise specified below.

H200 Wireless electronic components are not waterproof. **Do not immerse them in water.**

 **Caution:** Ensure that all components are unplugged and turned off prior to cleaning.

**Ensure they are completely dry prior to using again.**

### Control Unit Neck Strap and Wrist Strap

The Control Unit neck strap and Control Unit wrist strap are made of polyester. They may be machine washed on a delicate cycle in cold water.

### Orthosis Wrist Strap

Hand wash the Orthosis wrist strap in mild soap and cold water. The Orthosis wrist strap has a metal piece that may rust if machine washed.

### Orthosis Electrode Bases

The Orthosis electrode bases may be wiped with a clean, damp cloth.

## **Disinfecting**

### **Electronic Components**

The Control Unit may be cleaned and low-level disinfected using CaviWipes™ (if available), or wipes or cloths saturated (but not dripping) with 70% isopropyl alcohol (IPA) per the instructions below:

1. Use one saturated disinfectant wipe or cloth to thoroughly wet the component surface.
2. Use a second saturated disinfectant wipe or cloth to remove any surface contaminants. Soil, etc., will impede the disinfectant's effectiveness, if not removed.
3. As needed, use additional saturated disinfectant wipes or cloths to keep the components surface wet for 3 minutes.

Note: Be sure to follow the Bioness instructions for the specified contact time to ensure an effective bacteria kill.

### **Orthosis**

The Orthosis (except for the wrist insert) may be cleaned and low-level disinfected using wipes or cloths saturated with 70% isopropyl alcohol (IPA) per the instructions below:

1. Use one saturated disinfectant wipe or cloth to thoroughly wet the component surface.
2. Use a second saturated disinfectant wipe or cloth to remove any surface contaminants. Soil, etc., will impede the disinfectant's effectiveness, if not removed.
3. As needed, use additional saturated disinfectant wipes or cloths to keep the components surface wet for 3 minutes.

Note: Be sure to follow the Bioness instructions for the specified contact time to ensure an effective bacteria kill.

## Wrist Insert

The wrist insert cannot be disinfected. The wrist insert can only be cleaned with soap and water. Do not use 70% IPA on the wrist insert. If infection is a concern contact your clinician, the Bioness Client Relations Department at 800.211.9136, Option 3 (in the United States) or your local distributor (outside of the United States).

## System Kit Carrying Case

The H200 Wireless System Kit carrying case may be cleaned and low-level disinfected using CaviCide® (if available) or 70% isopropyl alcohol (IPA) per the following instructions:

### CaviCide:

1. Spray the entire surface of the System Kit carrying case with CaviCide.
2. Use a clean towel to remove any surface contaminants. Soil, etc., will impede the disinfectant's effectiveness, if not removed.
3. Spray the entire surface of the System Kit carrying case again with CaviCide.
4. Keep spraying the entire carrying case surface as needed to keep it wet for 10 minutes.

### 70% IPA:

1. Wipe the entire surface of the System Kit carrying case with a cloth or wipe saturated with 70% IPA.
2. Use a new cloth or wipe saturated with 70% IPA to remove any surface contaminants. Soil, etc., will impede the disinfectant's effectiveness, if not removed.
3. Wipe the entire surface of the System Kit carrying case again with a new cloth or wipe saturated with 70% IPA.
4. Use additional new cloths or wipes saturated with 70% IPA as needed to keep the entire surface of the carrying case wet for 10 minutes.



## **H200<sup>®</sup> Wireless**

Note: Be sure to follow the Bioness instructions for the specified contact time to ensure an effective bacteria kill.

Note: Do not use other cleaning/disinfecting agents such as a diluted bleach mixture, or other disinfecting wipes. Bioness has not tested these products' effectiveness on the H200 Wireless components.

70% IPA is available at your local drugstore or pharmacy.

## Electronic Registration of Replacement Parts

The H200 Wireless System Control Unit and Orthosis must be electronically registered to each other to communicate wirelessly. The components in your System Kit are electronically registered.

When you purchase a replacement Control Unit or Orthosis, the replacement component must be electronically registered to the existing component. This section describes the steps to electronically register a replacement Control Unit or Orthosis.

Note: When registering a replacement component, make certain that there are no other H200 Wireless systems within 3 meters (10 feet) of the components being registered.

### Registration Setup

1. Verify that all H200 Wireless System components are turned off.
2. Place the components to be registered close together on a table, but not touching. See Figure 12-1.

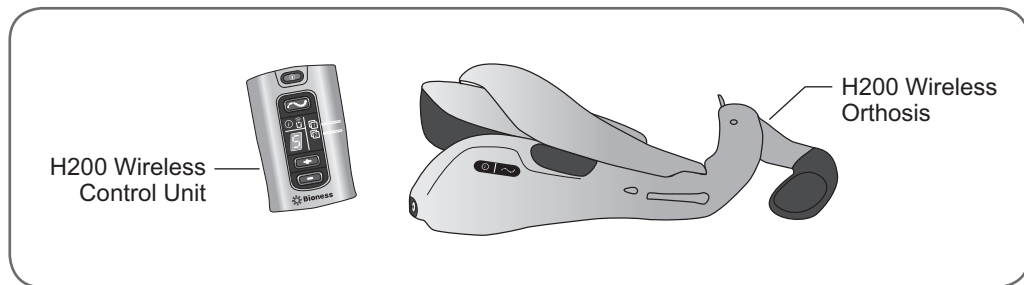

Figure 12-1: Placement of Components to be Registered

3. If necessary, connect the components to the System Charger set, and plug the System Charger into a power outlet.
4. Locate the System ID Number (for example, A334) on the existing system component. The System ID Number is on the back of the Control Unit and under the extensor wing of the Orthosis. See Figure 12-2.

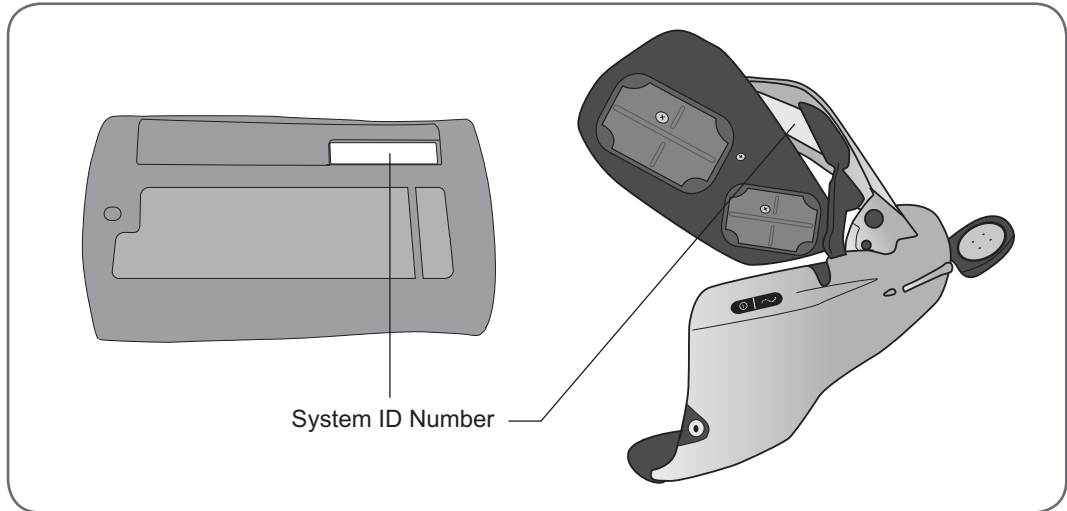



Figure 12-2: Location of the System ID Numbers

5. Copy the System ID Number onto the blank label on the replacement system component.

## Registration

1. Simultaneously press and hold for three seconds the trigger button  and the minus button  on the Control Unit.
2. Press the trigger button on the wrist bridge of the Orthosis.
3. The Control Unit will beep when registration begins.





4. The Control Unit digital display will show two alternating Green arches  while registration is in process. See Figure 12-3.



Figure 12-3: Registration Digital Displays

5. When registration is complete:

- The letter "C" will appear in the digital display.
- The Control Unit status light  and the Orthosis status light  will turn Green for a few seconds.
- The Control Unit will beep.

Note: If a letter "E" appears in the digital display and the Control Unit status light turns Red, an error has occurred. Turn on the Control Unit. If a letter "U"  appears in the digital display, the system is unregistered. Turn the Control Unit off and repeat the registration process.

Note: Components can only be successfully registered once. Additional attempts will generate an error indication.

6. After registration is complete, turn on your H200 Wireless System. If the Control Unit is registered to the Orthosis, the Orthosis will turn on.

Note: If the RF communication indicator  on the Control Unit is Flashing Red, registration failed. Repeat the registration procedure.



## Troubleshooting

If you have any questions or concerns, please call the Bioness Client Relations Department at 800.211.9136, Option 3 (in the United States) or your local distributor (outside of the United States).



### RF Communication Failure

The Orthosis and Control Unit communicate wirelessly. If RF communication fails, the Control Unit RF Indicator will flash red and emit an audio alert.

RF Failure Alert	Problems/Solutions
 <p data-bbox="220 824 371 878">Control Unit Flashes Red</p>	<p data-bbox="454 677 838 701"><b>Radio Communication Failure</b></p> <ul data-bbox="454 707 1157 957" style="list-style-type: none"> <li>• Make sure the Orthosis and the Control Unit are within 3 meters (10 feet) of each other.</li> <li>• If the components are within range and working properly, then turn the Control Unit off and back on.</li> <li>• Reorient the Control Unit.</li> <li>• Check for obstructions or sources of interference.</li> <li>• Change the cloth electrodes.</li> <li>• Contact the Bioness or your local distributor.</li> </ul>

### Frequently Asked Questions

**When charging the H200 Wireless System, how will I know when the batteries are fully charged?**

- When the Control Unit is fully charged, a green horizontal line  will appear in the Control Unit digital display.
- When the Orthosis is fully charged, the status light  on the Orthosis will be a steady green.

## H200<sup>®</sup> Wireless

- Charging takes approximately four hours, but the Control Unit can take as long as six hours to charge.
- After the components are fully charged, keep them connected to the System Charger until ready to use.

### **If I charge the H200 Wireless System every day, will I harm the batteries?**



- No, daily charging will not affect the lifespan or functionality of the batteries. Daily charging is recommended.

### **While charging the Control Unit, the status light on the Control Unit turns red.**

- A charging error has occurred. Reconnect the System Charger Y cable. If the problem persists, contact Bioness or your local distributor.

### **When I turn on the H200 Wireless Control Unit, it beeps and the RF communication indicator flashes red. The status light and stimulation light on the Orthosis are not lit.**

RF communication has failed. The Orthosis battery most likely is discharged.

- Connect the System Charger. When communication is restored, the RF  communication indicator will stop flashing and the status light  on the Orthosis will flash green.

### **I hear a beep and the status light on the Orthosis flashes red.**

A faulty electrode contact error has occurred. One or more of the cloth electrodes is not in contact with the skin.

- Turn off the Control Unit and remove the Orthosis.
- Thoroughly clean the skin, removing any oils.
- Remove and examine the cloth electrodes. If the cloth electrodes are old or damaged, then replace them.

- Clean the electrode bases, if necessary.
- Wet and replace the cloth electrodes.
- Make sure the extensor wing is closed properly.

### **How will I know when the Orthosis battery charge level is low?**

- When the Orthosis battery charge level is low, the status light  on the Orthosis will flash yellow and the Orthosis will beep.

### **How will I know when the Control Unit battery charge level is low?**

- When the Control Unit battery charge level is low, the status light  on the Control Unit will flash yellow and the Control Unit will beep.

**The status light  on the Control Unit is a steady red and the Control Unit beeped.**

If the Control Unit is connected to the System Charger and stimulation is not affected, a charging error has occurred.

- Reconnect the charger.
- Change the battery.
- If the problem persists, contact Bioness or your local distributor.

If the Control Unit is not connected to the System Charger and the system does not operate, a Control Unit hardware or software malfunction has occurred.

- Turn off the Control Unit and turn it back on.
- If the problem persists, stop using the system and contact Bioness or your local distributor.



### **My hand is not moving satisfactorily, and the H200 Wireless System is not indicating any errors.**

The Orthosis may not be positioned correctly.

- Turn off the Control Unit.
- Make sure the cloth electrodes are wet and your hand/arm are clean.
- Reposition the Orthosis.
- Make sure the thenar is at the base of your thumb.
- Make sure the Orthosis wrist strap is snug.
- Make sure the extensor wing is completely closed.
- Test the position of the Orthosis using the stimulation test button  .

### **My skin is irritated where the cloth electrodes touch.**

- Stop using the H200 Wireless System immediately.
- Contact your clinician or dermatologist, and the Bioness Client Relations Department at 800.211.9136, Option 3 (in the United States) or your local distributor (outside of the United States).
- Resume use only when your skin is completely healed.
- Ask your clinician or dermatologist for a skin conditioning protocol.

### **The Control Unit does not light up when turned on.**

- The Control Unit needs to be charged.
- If the problem persists, contact Bioness or your local distributor.

**I received a replacement Control Unit. When I turn it on, the RF communication indicator flashes red and a "U" appears in the digital display. The Orthosis status light and stimulation light are not lit.**

A replacement component needs to be electronically registered to the existing component for the H200 Wireless System to communicate wirelessly.

- For instructions on how to register a replacement component, see the "Electronic Registration of Replacement Parts" section of this guide.













**I tried the electronic registration procedure, but I never saw the alternating arches in the digital display. The replacement component is not working.**



- Turn off the Control Unit.
- Simultaneously press the minus button  and the trigger button  on the Control Unit. Then press the trigger button on the Orthosis, to start the registration process.







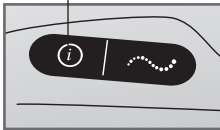

**After I fully charged the H200 Wireless System, I disconnected the System Charger and then immediately reconnected it. The charging indications appeared again on the Control Unit and Orthosis. Are the components fully charged or do I need to repeat the charging process?**

- The components are fully charged. You do not need to repeat the charging process.

## Quick Reference Troubleshooting

Control Unit	Description	Definition
	Control Unit Status Indicator Flashes Yellow	Low Battery, H200 Wireless Control Unit
	Control Unit Status Indicator is a Steady Red	Control Unit Charging Error; Electronic Registration Error; Control Unit Hardware/Software Error
	Program 1 Indicator is Green	Program 1 Selected
	Program 2 Indicator is Green	Program 2 Selected
	RF Communication Indicator Flashes Red	RF Communication Error
	On/Off Button Flashes Green	System On
	Trigger Button Flashes Yellow Rapidly	Stimulation On
	Trigger Button is a Steady Yellow	Stimulation Paused
	Displays 0–9	Stimulation Intensity Level; "0" Equals No Stimulation
	Alternating Green Arches	Registration in Process
	Letter "C"	Registration Complete
	Letter "E"	Registration Error

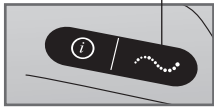
Control Unit	Description	Definition
	Letter "U"	Control Unit Unregistered
	Rotating Green Circle	Control Unit Charging
	Horizontal Green Line	Control Unit Fully Charged

Left Orthosis	Display	Description	Definition
<p>Status Light</p> 		Flashes Green	System On
		Flashes Yellow	Low Battery
		Alternately Flashes Yellow and Green	Battery Charging
		Steady Green	Battery Fully Charged; Registration Successful
		Flashes Red	Faulty Electrode Contact
		Steady Red	Hardware/Software Error; Charging Error
<p>Stimulation Light</p> 		Steady Yellow	Stimulation Paused
		Flashes Yellow Rapidly	Stimulation On



## Technical Specifications

<b>H200 Wireless Control Unit Specifications</b>	
<b>Classification</b>	Internally powered, continuous operation
<b>Operation Modes</b>	User and Standby
<b>Battery Type</b>	Rechargeable AAA NiMH 1.2 V, 900–1100 mAh
<b>Controls</b>	<ul style="list-style-type: none"> <li>• On/Off illuminated button</li> <li>• Trigger illuminated button to turn on and pause stimulation</li> <li>• Intensity +/- buttons to fine-tune intensity level</li> <li>• Mute button to mute audio alerts</li> <li>• Program selection buttons (1, 2)</li> <li>• Stimulation test button</li> </ul>
<b>Indications</b>	<ul style="list-style-type: none"> <li>• Four status icons: H200 Wireless Control Unit, RF Communication Status, Selected Program (1, 2)</li> <li>• Digital display designates relative stimulation intensity</li> <li>• Illuminated buttons designate system on/off and stimulation on/off or paused.</li> <li>• “Beeps” for audio alerts</li> </ul>
<b>Carrying Options</b>	In pocket, neck strap, wrist strap, or belt pouch
<b>Dimensions</b>	Length: 73 mm (2.9 in.); Width: 46 mm (1.8 in.); Height: 18 mm (0.7 in.)
<b>Weight</b>	45 grams (1.5 oz.)
<b>Environmental Ranges</b>	<ul style="list-style-type: none"> <li>• Transport and storage temperature: -25°C to +70°C (-13°F to +158°F)</li> <li>• Operating conditions temperature: 5°C to 40°C (41°F to 104°F)</li> <li>• Operating conditions relative humidity: 15% to 93%</li> <li>• Charging temperature: 5°C to 40°C (41°F to 104°F)</li> <li>• Shipping pressure: 30 kPa (equivalent to approximately 9,100 meters above sea-level) for up to 10 hours</li> <li>• Operating Pressure: 70 kPa to 106 kPa</li> <li>• IP classification: IP22</li> </ul>

<b>H200 Wireless Orthosis Specifications</b>			
<b>Classification</b>	Internally powered, continuous operation with type BF applied parts		
<b>Operating Voltage</b>	3.7 V		
<b>Battery Type</b>	Proprietary rechargeable Li-Ion (Lithium Ion) 3.7 V, 280–350 mAh		
<b>Indications</b>	<ul style="list-style-type: none"> <li>• H200 Wireless Orthosis status (fault, battery, charging) and Stimulation LEDs</li> <li>• “Beeps” for audio alerts</li> </ul>		
<b>Material</b>	<ul style="list-style-type: none"> <li>• Main body cover: Rilsan BZM 30 OTL</li> <li>• Wing cover: TEREZ ABS 5010</li> <li>• Wrist insert: Flexible foam, two components urethane non-integral skin, Purtec GMBH</li> <li>• Thenar: Dow Corning Silicone Rubber NPC 40</li> </ul>		
<b>Configurations</b>	<ul style="list-style-type: none"> <li>• Size: Small/Medium/Large</li> <li>• Side: Left and Right</li> <li>• Total of 6 configurations</li> </ul>		
<b>Environmental Ranges</b>	<ul style="list-style-type: none"> <li>• Transport and storage temperature: -25°C to +70°C (-13°F to +158°F)</li> <li>• Operating conditions temperature: 5°C to 40°C (41°F to 104°F)</li> <li>• Operating conditions relative humidity: 15% to 93%</li> <li>• Shipping pressure: 30 kPa (equivalent to approximately 9,100 meters above sea-level) for up to 10 hours</li> <li>• Charging temperature: 5°C to 40°C (41°F to 104°F)</li> <li>• IP classification: IP27</li> </ul>		
	<b>Small</b>	<b>Medium</b>	<b>Large</b>
<b>Dimensions (closed)</b>	Length: 270 mm (10.63 in.) Width: 110 mm (4.33 in.) Depth: 90 mm (3.54 in.)	Length: 270 mm (10.63 in.) Width: 110 mm (4.33 in.) Depth: 90 mm (3.54 in.)	Length: 300 mm (11.81 in.) Width: 130 mm (5.11 in.) Depth: 130 mm (5.11 in.)

<b>H200 Wireless Orthosis Specifications</b>			
<b>Estimated Weight</b>	300 grams (10.58 oz.)	300 grams (10.58 oz.)	300 grams (10.58 oz.)
<b>H200 Wireless Orthosis Pulse Parameters</b>			
<b>Pulse</b>	Balanced Biphasic		
<b>Waveform</b>	Symmetric		
<b>Intensity (Peak)</b>	0–80 mA, 1-mA resolution (positive phase)		
<b>Maximum Current Intensity (rms)</b>	<ul style="list-style-type: none"> <li>• Electrodes #1, #2, #3, #5: 13.1 mA rms</li> <li>• Electrode #4: 18.6 mA rms</li> </ul>		
<b>Max Voltage</b>	120 V		
	<b>Symmetric</b>		
<b>Positive Pulse Duration (μsec)</b>	100	200	300
<b>Negative Pulse Duration (μsec)</b>	100	200	300
<b>Inter-Phase Interval (μsec)</b>	50		
<b>Max Total Pulse Duration (μsec)</b>	250	450	650
<b>Load Range</b>	0–5000 ohm (Subject to max voltage limitation)		
<b>Nominal Load</b>	500 ohm		
<b>Max Power Load</b>	500 ohm (80 mA, 120 V)		
<b>Pulse Repetition Rate</b>	20–45 Hz, 5-Hz resolution		
<b>Ramp Up</b>	0–3.1 seconds		
<b>Ramp Down</b>	0–3.1 seconds		
<b>Max. Duration of Stimulation Program</b>	4 hours, 5-minute resolution		



Power Supply Specifications	
Use medical Class II safety approved power supply provided/approved by Bioness with the following ratings:	
Input	
Voltage	100–240 VAC
Current	400 mA
Frequency	50/60 Hz
Output	
Voltage	5 V ± 5%
Current	2400 mA

**Note:** The H200 Wireless Control Unit and Orthosis can be used while charging if the Control Unit is not connected to the Clinician's Programmer.

H200 Wireless Cloth Electrode Specifications						
<b>Material</b>	Non-woven cloth <b>Note:</b> Use only cloth electrodes provided by Bioness Inc.					
<b>Cloth Electrode #</b>	1	2	3 Regular	3 Large	4	5
<b>Area (mm<sup>2</sup>)</b>	1784	1185	791	1284	2038	1185
<b>Area (in.<sup>2</sup>)</b>	2.8	1.8	1.2	2.0	3.2	1.8

<b>Wireless Technology Description</b>	
<b>Wireless Link Specifications</b>	
<b>Frequency Band</b>	2.4 GHz, ISM band
<b>Transmission Power</b>	Complies with FCC 15.247 (for U.S.) regulations/ETSI EN300-440 (For Europe) regulations.
<b>Transmitters</b>	
<b>Operating Frequency Band</b>	2401–2482 MHz
<b>Type of Modulation</b>	FSK
<b>Type of Modulating Signal</b>	Binary data message
<b>Data Rate [=Frequency of Modulating Signal]</b>	250 Kbps
<b>Modulation Baud Rate</b>	250 KHz
<b>Modulation Bandwidth</b>	812 KHz
<b>RFSO Transmitter EIRP</b>	+1 dBm
<b>CU Transmitter EIRP</b>	+1 dBm
<b>Receivers</b>	
<b>Operating Frequency Band</b>	2401–2482 MHz
<b>Receiver Bandwidth</b>	812 kHz around a selected frequency

<b>Wireless Technology Characteristics</b>	
<b>RF Frequency Channels</b>	83 channels
<b>Channel Spacing</b>	25 MHz.
<b>Antenna Type</b>	Integral, max gain: +1dBi. No antenna connector.
<b>Transceiver Duplexing Scheme</b>	TDD
<b>Frequency Synthesizer Setting Time</b>	<1 msec
<b>Error Detection Probability</b>	A miss detection rate of the CRC-16 is about $1.2 \times 10^{-9}$ . HW filter and 6 bytes unique ID to each component.
<b>Packet Error Rate</b>	Less than 5%
<b>Receiver Sensitivity Pr</b>	-80 to -75 dBm for PER + 3%
<b>Command Delay</b>	Less than 1 second

## Appendix - EMI Tables

<b>Guidance and Manufacturer's Declaration Electromagnetic Emissions</b>		
The H200 Wireless System is intended for use in the electromagnetic environment specified below. The customer or the user of the H200 Wireless System should assure that it is used in such an environment.		
<b>Emissions Test</b>	<b>Compliance</b>	<b>Electromagnetic Environment — Guidance</b>
RF emissions CISPR 11	Group 1	The H200 Wireless System uses RF energy only for its internal function. Therefore, its RF emissions are very low and are not likely to cause any interference in nearby electronic equipment.
RF emissions CISPR 11	Class B	The H200 Wireless System is suitable for use in all establishments, including domestic establishments and those directly connected to the public low-voltage power supply network that supplies buildings used for domestic purposes.
Harmonic emissions IEC 61000-3-2	Class A	
Voltage fluctuations/ flicker emissions IEC 61000-3-3	Complies	

## Guidance and Manufacturer's Declaration— Electromagnetic Immunity for All Equipment and Systems

The H200 Wireless System is intended for use in the electromagnetic environment specified below. The customer or the user of the H200 Wireless System should assure that it is used in such an environment.

Immunity Test	IEC 60601 Test Level	Compliance Level	Electromagnetic Environment— Guidance
Electrostatic discharge (ESD) IEC 61000-4-2	6 kV contact 8 kV air	6 kV contact 8 kV air	Floors should be wood, concrete, or ceramic tile. If floors are covered with synthetic material, the relative humidity should be at least 30%.
Electrical fast transient/burst IEC 61000-4-4	2 kV for power supply lines 1 kV for input/output lines	2 kV for power supply lines	Mains power quality should be that of a typical commercial or hospital environment.
Surge IEC 61000-4-5	1 kV line to line 2 kV line to earth	1 kV line to line (Class II without any grounded interconnections)	Mains power quality should be that of a typical commercial or hospital environment.

Immunity Test	IEC 60601 Test Level	Compliance Level	Electromagnetic Environment—Guidance
Voltage dips, short interruptions and voltage variations on power supply input lines IEC 61000-4-11	<p>&lt;5% <math>U_T</math> (&gt;95% dip in <math>U_T</math>) for 0.5 cycle</p> <p>40% <math>U_T</math> (60% dip in <math>U_T</math>) for 5 cycles</p> <p>70% <math>U_T</math> (30% dip in <math>U_T</math>) for 25 cycles</p> <p>&lt;5% <math>U_T</math> (&gt;95% dip in <math>U_T</math>) for 5 sec</p>	<p>&lt;5% <math>U_T</math> (&gt;95% dip in <math>U_T</math>) for 0.5 cycle</p> <p>40% <math>U_T</math> (60% dip in <math>U_T</math>) for 5 cycles</p> <p>70% <math>U_T</math> (30% dip in <math>U_T</math>) for 25 cycles</p> <p>&lt;5% <math>U_T</math> (&gt;95% dip in <math>U_T</math>) for 5 sec</p>	<p>Mains power quality should be that of a typical commercial or hospital environment. If the user of the H200 Wireless System requires continued operation during power mains interruptions, it is recommended that the equipment be powered from an uninterruptible power supply or a battery.</p>
Power frequency (50/60 Hz) magnetic field IEC 61000-4-8	3 A/m	3 A/m	<p>Power frequency magnetic fields should be at levels characteristic of a typical location in a typical commercial or hospital environment.</p>
<p>NOTE: <math>U_T</math> is the AC mains voltage prior to application of the test level.</p>			

<b>Guidance and Manufacturer's Declaration—Electromagnetic Immunity</b>			
The H200 Wireless System is intended for use in the electromagnetic environment specified below. The customer or the user of the H200 Wireless System should assure that it is used in such an environment.			
<b>Immunity Test</b>	<b>IEC 60601 Test Level</b>	<b>Compliance Level</b>	<b>Electromagnetic Environment—Guidance</b>
			Portable and mobile RF communications equipment should be used no closer to any part of the H200 Wireless System, including cables, than the recommended separation distance calculated from the equation applicable to the frequency of the transmitter.
Conducted RF IEC 61000-4-6	3 Vrms 150 kHz to 80 MHz	3 Vrms 150 kHz to 80 MHz	<b>Recommended separation distance:</b> $d = 1.2\sqrt{P}$
Radiated RF IEC 61000-4-3	3 V/m 80 MHz to 2.5 GHz	$[E_{ref}] = 3 \text{ V/m}$ in 80 MHz to 2.5 GHz $[E_{ref}] = 10 \text{ V/m}$ in 26 MHz to 1 GHz	<b>Recommended separation distance:</b> $d = 0.4\sqrt{P}$ , 80–800 MHz range $d = 0.7\sqrt{P}$ , 800–1000 MHz range $d = 2.3\sqrt{P}$ , 1000–2500 MHz range

NOTE 1: At 80 MHz and 800 MHz, the higher frequency range applies.

NOTE 2: These guidelines may not apply in all situations. Electromagnetic propagation is affected by absorption and reflection from structures, objects, and people.

NOTE 3:  $P$  is the maximum output power rating of the transmitter in watts (W) according to the transmitter manufacturer and  $d$  is the recommended separation distance in meters (m).

NOTE 4: Field strengths from fixed RF transmitters, as determined by an electromagnetic site survey,<sup>a</sup> should be less than the compliance level in each frequency range.<sup>b</sup>

NOTE 5: Interference may occur in the vicinity of equipment marked with the following symbol:



<sup>a</sup> Field strengths from fixed transmitters, such as base stations for radio (cellular/cordless) telephones and land mobile radios, amateur radio, AM and FM radio broadcast, and TV broadcast cannot be predicted theoretically with accuracy. To assess the electromagnetic environment due to fixed RF transmitters, an electromagnetic site survey should be considered. If the measured field strength in the location in which the H200 Wireless System is used exceeds the applicable RF compliance level above, the H200 Wireless System should be observed to verify normal operation. If abnormal performance is observed, additional measures may be necessary, such as re-orienting or relocating the H200 Wireless System.

<sup>b</sup> Over the frequency range 150 kHz to 80 MHz, field strengths should be less than 3 V/m.



## Recommended Separation Distances Between Portable and Mobile RF Communications Equipment and the H200 Wireless System

The H200 Wireless System is intended for use in an electromagnetic environment in which radiated RF disturbances are controlled. The customer or the user of the H200 Wireless System can help prevent electromagnetic interference by maintaining a minimum distance between portable and mobile RF communications equipment (transmitters) and the H200 Wireless System as recommended below, according to the maximum output power of the communications equipment.

Rated Maximum Output Power of Transmitter (W)	Separation Distance According to Frequency of Transmitter			
	150 kHz to 80 MHz Outside ISM Bands $d = 1.2\sqrt{P}$	80 MHz to 800 MHz $d = 0.4\sqrt{P}$	800 MHz to 1000 MHz $d = 0.7\sqrt{P}$	1000 MHz to 2.5 GHz $d = 2.3\sqrt{P}$
0.01	4.7 in. (0.12 m)	1.6 in. (0.04 m)	2.8 in. (0.07 m)	9.1 in. (0.23 m)
0.1	15 in. (0.38 m)	5.2 in. (0.13 m)	8.7 in. (0.22 m)	2 ft 5 in. (0.73 m)
1	3 ft 11 in. (1.2 m)	15 ft 7 in. (0.4 m)	2 ft 4 in. (0.7 m)	7 ft 7 in. (2.3 m)
10	12 ft 6 in. (3.8 m)	4 ft 2 in. (1.3 m)	7 ft 3 in. (2.2 m)	24 ft 11 in. (7.3 m)
100	39 ft 4 in. (12 m)	13 ft 1 in. (4 m)	23 ft (7 m)	75 ft 6 in. (23 m)

Note 1: At 80 MHz and 800 MHz, the higher frequency range applies.

Note 2: These guidelines may not apply in all situations. Electromagnetic propagation is affected by absorption and reflection from structures, objects, and people.

For transmitters rated at a maximum output power not listed above, the recommended separation distance  $d$  in meters (m) can be determined using the equation applicable to the frequency of the transmitter, where  $P$  is the maximum output power rating of the transmitter in watts (W) according to the transmitter manufacturer.

Note: All calculations were made according to tables 204 and 206 of IEC 60601-1-2 for equipment that is not life-supporting using factors of 3.5 in 0.15–800 MHz and 7 in 800–2500 MHz. There are no requirements for ISM bands in these tables.

